



# PRODUCT PRICE LIST

## APRIL 2026



 **SPARES WEBSTORE**  
Purchase Blueseal Spares directly online  
[spares.blue-seal.co.uk](http://spares.blue-seal.co.uk)

SPARES - 0121 322 6646  
SERVICE - 0121 322 6647



**New customers get 10% off first order**



**BLUE SEAL EVOLUTION SERIES**

**COBRA**  
YOUR STYLE. YOUR WAY

**turbofan**

**VEERAY**

**Fastfri**

## Contact Details

Sales Office: T. 0121-327-5575 F. 0121-327-9711  
Spares: T. 0121-322-6640 / 0121-322-6641, F. 0121-327-9201  
Service: T. 0121-322-6644, F. 0121-327-6257  
Operating Hours: Mon-Thurs 8.45-4-45. Friday 8.45-4.15.

David Chesshire, National Accounts Manager 07764-663174  
Philip Basson, Sales Manager 07764-663175  
Donald Harvey, Sales Manager 07764-663176

## Test Kitchen & Technical Support

Our fully equipped on-site test kitchen offers prospective customers the opportunity to experience the Blue Seal product range first hand in a commercial cooking environment. Product demonstrations are available on request and are conducted by experienced and knowledgeable personnel.

Our experienced and highly skilled technical support staff and a network of over 200 field service engineers provide excellent support to customers throughout the UK.

## Distribution & Delivery Options

Our central distribution hub is based at our Headquarters in Birmingham, close to the country's major motorway network, ideally placed for next day deliveries to most parts of the UK. Most models and spares are available ex-stock.

Units (Applicable UK Mainland Deliveries ONLY)  
Delivery in four days – free of charge  
Next day up to 5pm – £65.00  
Next day before 12 noon – £80.00  
Next day timed – £100.00

**You are strongly advised not to book any installation engineers until you have received delivery and have inspected the goods. Blue Seal will not be held liable for any cost incurred due to late delivery or damage.**

Spares  
UK mainland £10.00 per consignment (FOC for orders over £50.00)  
Ireland, Channel Islands and Isle of Man £20.00 per consignment  
Northern Ireland £20.00 per consignment  
To guarantee next day delivery – orders must be received by 3.00pm. Next day deliveries to the Scottish Highlands cannot be guaranteed.

Please note any damages or discrepancies must be reported within 72 hours of delivery. For damage claims we require photos of the packaging and the damage to the item. Any claims made after this time or without photos may not be honoured.  
When returning damaged items please return them in the original packaging.

## Product Information

CAD library and high quality product images are available to specifiers, dealers and end users on request or on our website at [www.blue-seal.co.uk](http://www.blue-seal.co.uk).

## Spares

We understand the importance of an accurate spares identification, ordering and fast turnaround facility and that's why we've created a dedicated spares section on our website.

You'll find expandable technical drawings of every unit in our range, plus complementary lists of the relevant spares complete with full description and part numbers.  
[www.blue-seal.co.uk](http://www.blue-seal.co.uk)



Over 300 catering

**NEW CUSTOMERS  
GET 10% OFF  
ON FIRST ORDER**

**SPARES  
WEBSTORE**

**FREE SHIPPING  
ALL YEAR ROUND!!**

On all online orders over £50. Free freight to mainland only applied. Valid until 31 December 2016. [www.blue-seal.co.uk](http://www.blue-seal.co.uk)

\*ONLY VALID FOR PARTS AVAILABLE ONLINE THROUGH THE SPARES WEBSTORE



HEAVY DUTY EQUIPMENT



NEW PRODUCTS



MISCELLANEOUS



MEDIUM DUTY EQUIPMENT



CONVECTION OVENS



PIZZA & BAKERY EQUIPMENT



COMBINATION STEAMERS



WARE WASHING

equipment products for every kind of catering location

**BLUE SEAL EVOLUTION** SERIES

- New Products . . . . . 4 - 5
- Miscellaneous . . . . . 6 - 7
- Heavy Duty Modular Equipment . . . . . 8
- Gas Cooktops . . . . . 9 - 11
- Electric Cooktops . . . . . 12 - 15
- Induction Cooktops . . . . . 16 - 24
- Electric Sealed Hobs . . . . . 25 - 27
- Gas Oven Ranges . . . . . 28 - 33
- Gas Target Tops & Ranges . . . . . 34 - 35
- Electric Solid Top Hobs & Ranges 36 - 37
- Electric Oven Ranges . . . . . 38
- Gas Tilting Bratt Pans . . . . . 39
- Electric Tilting Bratt Pans . . . . . 40
- Gas Griddles . . . . . 41 - 44
- Electric Griddles . . . . . 45 - 48
- Gas Griddle Ovens . . . . . 49 - 50
- Gas Griddle Toaster . . . . . 50
- Electric Griddle Ovens . . . . . 51
- Gas Chargrills . . . . . 52 - 53
- Electric Chargrills . . . . . 54 - 55
- Gas & Electric Salamanders . . . . . 56 - 57
- Gas Fryers . . . . . 58 - 59
- Electric Fryers . . . . . 60 - 61
- Fryer Filters . . . . . 62
- Pasta Cookers . . . . . 63
- In-Fill Tables . . . . . 64 - 65
- Optional Extras . . . . . 65 - 66

**COBRA®**  
YOUR STYLE. YOUR WAY

- Medium Duty Modular Equipment. 67 - 75

**turbofan®**

- High Speed Convection Ovens . . . 76 - 82
- Bake-Off Ovens, Provers . . . . . 83 - 85 & Holding Cabinets
- Ventless Hoods . . . . . 85

**BLUE SEAL®**

- Combination Steamers . . . . . 86 - 88
- Pizza Ovens & Mixers . . . . . 89 - 90
- Ware Washing Equipment . . . . . 91 - 92
- Conditions of Sale . . . . . 93 - 95

# NEW PRODUCTS

Model	Hob Options	Dimensions	Gas Power kW	Price (exc. VAT)
-------	-------------	------------	--------------	------------------



900mm TARGET TOP

STATIC OVEN



**E570**

**Electrical requirements:**  
17.3kW, 400-415Vac, 50/60Hz,  
3P+N+E, 30.8A

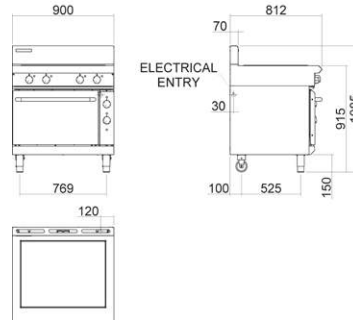

17.3

£8,400.00

E570



900mm INDUCTION RANGE

CONVECTION OVEN - 4 FULL AREA ZONES - 2/1 GN



**IN54F**

**Electrical requirements:**  
26.1kW, 400-415V,  
50/60Hz, 3P+N+E, 36.3A

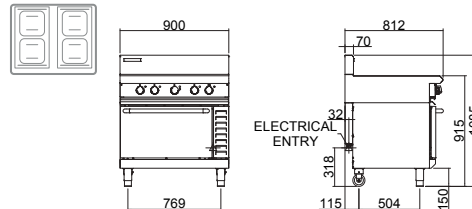

£21,065.00

IN54F



900mm INDUCTION RANGE

CONVECTION OVEN - 4 ROUND ZONES - 2/1 GN



**IN54R3**

**Electrical requirements:**  
20.1kW, 400-415V,  
50/60Hz, 3P+N+E, 28.5A

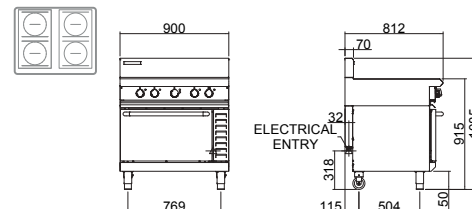

£19,585.00

IN54R3

**IN54R5**

**Electrical requirements:**  
26.1kW, 400-415V,  
50/60Hz, 3P+N+E, 36.3A



£19,935.00



900mm ELECTRIC CHARRILL

LEG STAND



**E596D-LS**

**Electrical requirements:**  
13.4kW, 400-415V,  
50/60Hz, 3P+N+E, 22.5A

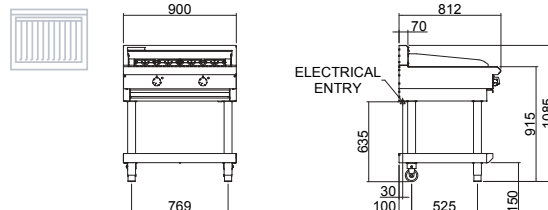

£8,385.00

E596D-LS

## NEW PRODUCTS

## HOT HOLDING CABINETS

Model	Hob Options	Dimensions	Gas Power kW	Price (exc. VAT)
-------	-------------	------------	--------------	------------------



H8D-UC

H8D-UC	HOLDING CABINET			
--------	-----------------	--	--	--

W 610mm x D 680mm x H 810mm		1.2	£5,200.00	
<ul style="list-style-type: none"> <li>• 8 x 1/1 GN tray capacity</li> <li>• 74mm tray spacing</li> <li>• 1.2kW heating power</li> <li>• Electronic touch sensitive control panel</li> </ul>				



H8D-FS-UC

H8D-FS-UC	HOLDING CABINET			
-----------	-----------------	--	--	--

W 735mm x D 810mm x H 810mm		1.9	£5,330.00	
<ul style="list-style-type: none"> <li>• 8 full size 460mm x 660mm / 18" x 26" sheet pan capacity</li> <li>• 74mm tray spacing</li> <li>• 1.9kW heating power</li> <li>• Electronic touch sensitive control panel</li> </ul>				



H10D-FS

H10D-FS	HOLDING CABINET			
---------	-----------------	--	--	--

W 735mm x D 810mm x H 1015mm		1.9	£5,610.00	
<ul style="list-style-type: none"> <li>• 10 full size 460mm x 660mm / 18" x 26" sheet pan capacity</li> <li>• 74mm tray spacing</li> <li>• 1.9kW heating power</li> <li>• Electronic touch sensitive control panel</li> </ul>				



H10D

H10D	HOLDING CABINET			
------	-----------------	--	--	--

W 610mm x D 680mm x H 1015mm		1.2	£5,355.00	
<ul style="list-style-type: none"> <li>• 10 1/1 GN pan capacity</li> <li>• 74mm tray spacing</li> <li>• 1.2kW heating power</li> <li>• Electronic touch sensitive control panel</li> </ul>				



EHT10-L

EHT10-L	TOUCH SCREEN ELECTRIC HUMIDIFIED HOLDING CABINET			
---------	--	--	--	--

W 610mm x D 680mm x H 1015mm		2.3	£7,045.00	
<ul style="list-style-type: none"> <li>• 10 1/1 GN pan capacity</li> <li>• 2.3kW heating power</li> <li>• Electronic touch sensitive control panel</li> </ul>				

### OPTIONAL EXTRAS

<b>SKEHT10</b>	Stainless steel stand with castors (2 with swivel lock) to suit EHT10-L model W610mm x D 727mm x H 609mm	£735.00
<b>237472</b>	Double stacking kit to suit E33/EHT10-L models	£245.00
<b>234347</b>	Filter head kit This kit supplies the cartridge mounting head assembly plus all associated plumbing/fittings for installation to P8/P12/P10/P85 probers. Also includes double check/pressure reducing valve and 2 metres of tubing for connection to supply	£350.00
<b>234562</b>	Filter Cartridge P124BN CUNO Filter cartridge itself for connection to above installation kit	£275.00

# MISCELLANEOUS

Model	Hob Options	Dimensions	Gas Power kW	Price (exc. VAT)
-------	-------------	------------	--------------	------------------

**Fastfri**

**FF18**

**GAS FRYER 400mm**



**FF18**

400mm wide single pan fryer  
Stainless steel finish  
18 litre oil capacity  
Mechanical thermostat  
Manual pilot ignition  
30mm drain valve  
90MJ multi-jet target burner  
25kg / hr production rate

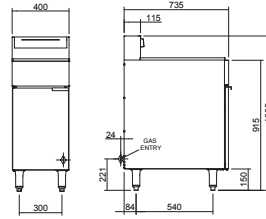

25

£2,055.00

**Splash Guards**

**237307** Left Hand  
**237308** Right Hand

£115.00  
£115.00



**G750-6**

**G750-6**

**GAS 6 BURNER RANGE STATIC OVEN**

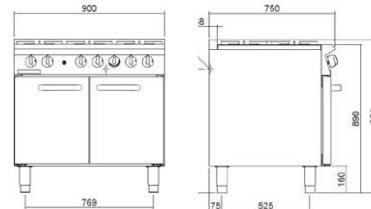

42.7

£3,170.00

Mobile castor kit P/No 238007 (x4 castors)  
UKSPSR6 Splash back and over shelf

£155.00  
£725.00



**QSET60/QSE60**

**QSET60**  
**QSE60**

**RAPID HEAT RISE & FALL GRILL**



**QSET60** 600mm wide x 450mm deep x 500mm high  
**QSET60** Plate detector as standard.

4

£4,075.00

**QSE60** 600mm wide x 450mm deep x 500mm high

4

£3,790.00

**9003** Wall brackets

£205.00

# MISCELLANEOUS

Model	Hob Options	Dimensions	Gas Power kW	Price (exc. VAT)
-------	-------------	------------	--------------	------------------



**E83**

**E83**

## FOOD WARMER



W 595mm x D 356mm x H 515mm

1

£1,060.00

- Temperature display
- Stay-cool door handles
- Easy-clean removable glass doors
- Anti-pilfer door locking clip
- Solid glass back option (no extra cost)
- Plugs into 10A power supply
- Capacity 50 pies
- Rack sizes 4 racks, 493 x 295mm
- Power Supply 220-240V 800W 3.4A
- Shipping Data 19.5kg, 0.16m3 packed

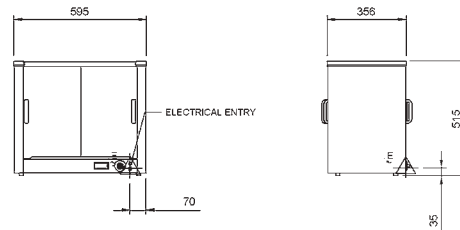

**E84**

**E84**

## FOOD WARMER



W 795mm x D 356mm x H 515mm

1.5

£1,155.00

- Thermostat control
- Temperature display
- Stay-cool door handles
- Easy-clean removable glass doors
- Anti-pilfer door locking clip
- Solid glass back option (no extra cost)
- Plugs into 10A power supply
- Capacity 80 – 100 pies
- Rack sizes 4 racks, 693 x 295mm
- Power Supply E84 220-240V 1100W 4.6A
- Shipping Data 25kg, 0.21m3 packed

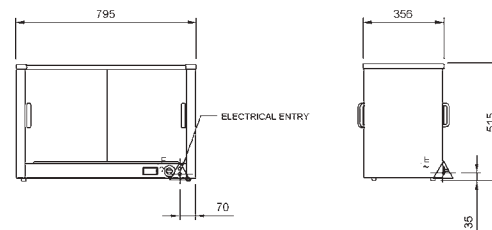

**GAS COOKTOPS**

Model	Hob Options	Dimensions	Gas Power kW	Price (exc. VAT)
-------	-------------	------------	--------------	------------------



**300mm COOKTOPS**

**BENCH MODEL**



G512D-B			14	£1,710.00
G512C-B			6	£2,050.00

**G512D-B**



**600mm**

**BENCH MODEL**



G514D-B			28	£3,180.00
G514C-B			20	£3,530.00
G514B-B			12	£3,850.00

**G514D-B**



**600mm**

**CABINET BASE**



G514D-CB			28	£3,570.00
G514C-CB			20	£3,895.00
G514B-CB			12	£4,230.00

**G514D-CB**

<b>OPTIONAL</b>	<b>228791</b>	<b>Gastronorm racking kit 1/1 GN / 4 position</b>	<b>£275.00</b>
-----------------	---------------	---	----------------



**600mm**

**LEG STAND**



G514D-LS			28	£3,385.00
G514C-LS			20	£3,740.00
G514B-LS			12	£4,075.00

**G514D-LS**

Note: Flame failure standard on open burners. Standard machined finish smooth griddle plate supplied.

Choice of griddle surfaces: Simply order the optional griddle plate model number and unit is supplied with your nominated surface. View options page 11.

# GAS COOKTOPS

Model	Hob Options	Dimensions	Gas Power kW	Price (exc. VAT)
-------	-------------	------------	--------------	------------------



## 900mm COOKTOPS

### BENCH MODEL



G516D-B			42	£3,815.00
G516C-B			34	£4,150.00
G516B-B			26	£4,465.00
G516A-B			18	£4,820.00

G516D-B



## 900mm

### CABINET BASE



G516D-CB			42	£4,645.00
G516C-CB			34	£4,985.00
G516B-CB			26	£5,310.00
G516A-CB			18	£5,640.00

G516D-CB

### OPTIONAL

**228791** Gastronorm racking kit 1/1 GN / 4 position / 900mm Cabinet Base £275.00  
Accommodates 1 or 2 Racking Kits



## 900mm

### LEG STAND



G516D-LS			42	£4,065.00
G516C-LS			34	£4,375.00
G516B-LS			26	£4,720.00
G516A-LS			18	£5,035.00

G516C-LS



## 900mm

### REFRIGERATED BASE, 2 x 1/1 GN DRAWERS



G516D-RB			42	£8,820.00
G516C-RB			34	£9,150.00
G516B-RB			26	£9,480.00
G516A-RB			18	£9,830.00

G516D-RB

Note: Flame failure standard on open burners. Standard machined finish smooth griddle plate supplied.

Choice of griddle surfaces: Simply order the optional griddle plate model number and unit is supplied with your nominated surface. View options page 11.

# GAS COOKTOPS

Model	Hob Options	Dimensions	Gas Power kW	Price (exc. VAT)
-------	-------------	------------	--------------	------------------

## 1200mm COOKTOPS

## BENCH MODEL



G518D-B				56	£4,645.00
G518C-B				48	£4,985.00
G518B-B				40	£5,310.00
G518A-B				32	£5,640.00

### G518B



## 1200mm

## CABINET BASE (RACKING KIT NOT INCLUDED)



G518D-CB				56	£5,470.00
G518C-CB				48	£5,805.00
G518B-CB				40	£6,150.00
G518A-CB				32	£6,465.00

### G518C-CB

### OPTIONAL

228791

Gastronorm racking kit fits 1/1 GN or 2/1 GN / 4 position / 1200mm Cabinet Base. Accommodates 1 or 2 Racking Kits

£275.00

## 1200mm

## LEG STAND



G518D-LS				56	£5,035.00
G518C-LS				48	£5,415.00
G518B-LS				40	£5,730.00
G518A-LS				32	£6,065.00

### G518-LS

## 1200mm

## REFRIG. BASE, 2x1/1 GN DRAWERS / 1x1/1 GN DOOR



G518D-RB				56	£10,055.00
G518C-RB				48	£10,405.00
G518B-RB				40	£10,730.00
G518A-RB				32	£11,065.00

Note: Flame failure standard on open burners. Standard machined finish smooth griddle plate supplied.

Choice of griddle surfaces: Simply order the optional griddle plate model number and unit is supplied with your nominated surface. View options page 11.

## GAS COOKTOPS

Model	Description	Price (exc. VAT)
300mm	<b>OPTIONAL GRIDDLE PLATE SURFACE</b>	
<b>PG312R3*</b>	300mm x 12mm Griddle plate – ribbed full	£1,155.00

600mm	<b>OPTIONAL GRIDDLE PLATE SURFACE</b>	
<b>PG612R3*</b>	600mm x 12mm Griddle plate – ribbed 300mm RH	£1,340.00
<b>PG612R6*</b>	600mm x 12mm Griddle plate – ribbed full	£1,780.00

900mm	<b>OPTIONAL GRIDDLE PLATE SURFACE</b>	
<b>PG912R3*</b>	900mm x 12mm Griddle plate – ribbed 300mm RH	£1,480.00
<b>PG912R5*</b>	900mm x 12mm Griddle plate – ribbed 450mm RH	£1,890.00
<b>PG912R9*</b>	900mm x 12mm Griddle plate – ribbed full	£2,940.00

900mm	<b>OPTIONAL GRIDDLE PLATE SURFACE FOR 1200mm WIDE HOBS</b>	
<b>PG912R3*</b>	900mm x 12mm Griddle plate – ribbed 300mm RH	£1,480.00
<b>PG912R5*</b>	900mm x 12mm Griddle plate – ribbed 450mm RH	£1,890.00
<b>PG912R9*</b>	900mm x 12mm Griddle plate – ribbed full	£2,940.00

### OPTIONAL EXTRAS GAS COOKTOPS

<b>228807</b>	Mobile castor kit (set of 2 lockable)	£150.00
<b>Flex3/4/51</b>	Flexihose 3/4 (flexible quick coupling hose & tether chain)	£265.00
<b>230013</b>	Bench shield, fits LH or RH of open burners	£135.00

**Note:** The standard plate is not included when ordering an optional griddle plate surface.

\*Options must be specified at the placement of order.

# ELECTRIC COOKTOPS

Model	Hob Options	Dimensions	Price (exc. VAT)
-------	-------------	------------	------------------



## 300mm COOKTOPS

## BENCH MODEL

**E512D-B**  
**Electrical requirements:**  
 4.8kW, 230-240Vac,  
 50/60Hz, 1P+N+E, 20A

**E512C-B**  
**Electrical requirements:**  
 3.4kW, 230-240Vac,  
 50/60Hz, 1P+N+E, 14.2A

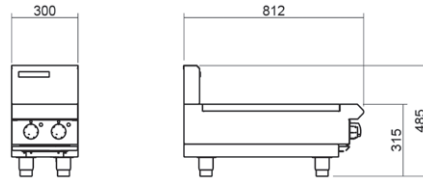

£1,800.00

£2,135.00

E512C -B



## 600mm COOKTOPS

## BENCH MODEL

**E514D-B**  
**Electrical requirements:**  
 9.6kW, 400-415Vac,  
 50/60Hz, 2P+N+E, 20A

**E514C-B**  
**Electrical requirements:**  
 8.2kW, 400-415Vac,  
 50/60Hz, 2P+N+E, 20A

**E514B-B**  
**Electrical requirements:**  
 6.8kW, 230-240Vac,  
 50/60Hz, 1P+N+E, 30A

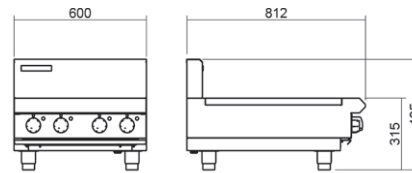

£3,815.00

£4,150.00

£4,490.00

E514C-B



## 600mm

## CABINET BASE (RACKING KIT NOT INCLUDED)

**E514D-CB**  
**Electrical requirements:**  
 9.6kW, 400-415Vac,  
 50/60Hz, 2P+N+E, 20A

**E514C-CB**  
**Electrical requirements:**  
 8.2kW, 400-415Vac,  
 50/60Hz, 2P+N+E, 20A

**E514B-CB**  
**Electrical requirements:**  
 6.8kW, 230-240Vac,  
 50/60Hz, 1P+N+E, 30A

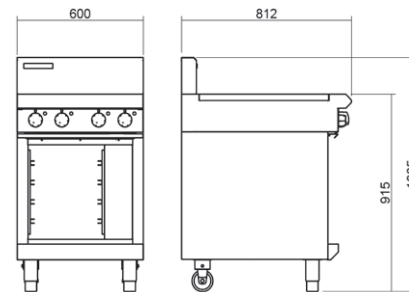

£4,065.00

£4,395.00

£4,720.00

E514D-CB

## OPTIONAL

228791















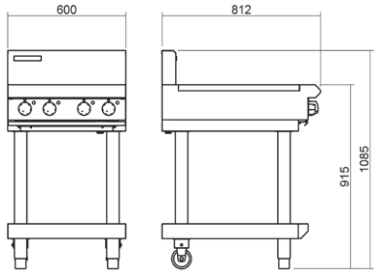

Gastronorm racking kit 1/1 GN / 4 position

£275.00

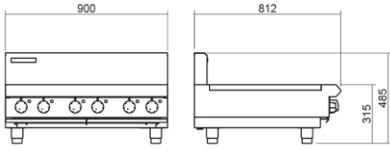
Note: Standard machined finish smooth griddle plate supplied.

Choice of griddle surfaces: Simply order the optional griddle plate model number and unit is supplied with your nominated surface. View options page 15.

# ELECTRIC COOKTOPS

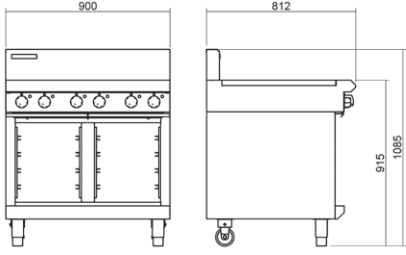
Model	Hob Options	Dimensions	Price (exc. VAT)	
<b>600mm COOKTOPS</b>		<b>LEG STAND</b>		
 <p><b>E514D-LS</b> Electrical requirements: 9.6kW, 400-415Vac, 50/60Hz, 2P+N+E, 20A</p> <p><b>E514C-LS</b> Electrical requirements: 8.2kW, 400-415Vac, 50/60Hz, 2P+N+E, 20A</p> <p><b>E514B-LS</b> Electrical requirements: 6.8kW, 230-240Vac, 50/60Hz, 1P+N+E, 30A</p>	  		<p>£4,000.00</p> <p>£4,330.00</p> <p>£4,655.00</p>	
	<b>900mm COOKTOPS</b>		<b>BENCH MODEL</b>	
	 <p><b>E516D-B</b> Electrical requirements: 14.4kW, 400-415Vac, 50/60Hz, 3P+N+E, 20A</p> <p><b>E516C-B</b> Electrical requirements: 13kW, 400-415Vac, 50/60Hz, 3P+N+E, 20A</p> <p><b>E516B-B</b> Electrical requirements: 11.6kW, 400-415Vac, 50/60Hz, 3P+N+E, 20A</p> <p><b>E516A-B</b> Electrical requirements: 10.2kW, 400-415Vac, 50/60Hz, 3P+N+E, 15A</p>	   		<p>£5,395.00</p> <p>£5,730.00</p> <p>£6,055.00</p> <p>£6,390.00</p>
<b>900mm</b>		<b>CABINET BASE (RACKING KIT NOT INCLUDED)</b>		
 <p><b>E516D-CB</b> Electrical requirements: 14.4kW, 400-415Vac, 50/60Hz, 3P+N+E, 20A</p> <p><b>E516C-CB</b> Electrical requirements: 13kW, 400-415Vac, 50/60Hz, 3P+N+E, 20A</p> <p><b>E516B-CB</b> Electrical requirements: 11.6kW, 400-415Vac, 50/60Hz, 3P+N+E, 20A</p> <p><b>E516A-CB</b> Electrical requirements: 10.2kW, 400-415Vac, 50/60Hz, 3P+N+E, 15A</p>		   		<p>£5,880.00</p> <p>£6,235.00</p> <p>£6,560.00</p> <p>£6,890.00</p>
		<b>OPTIONAL</b>	<b>228791</b>	<b>Gastronorm racking kit 1/1 GN / 4 position / 900mm Cabinet Base Accommodates 1 or 2 racking kits</b>

Note: Standard machined finish smooth griddle plate supplied.

Choice of griddle surfaces: Simply order the optional griddle plate model number and unit is supplied with your nominated surface. View options page 15.

# ELECTRIC COOKTOPS



**E516B-LS**

Model	Hob Options	Dimensions	Price (exc. VAT)
<b>900mm COOKTOPS</b>		<b>LEG STAND</b>	
<b>E516D-LS</b> Electrical requirements: 14.4kW, 400-415Vac, 50/60Hz, 3P+N+E, 20A			£5,730.00
<b>E516C-LS</b> Electrical requirements: 13kW, 400-415Vac, 50/60Hz, 3P+N+E, 20A			£6,055.00
<b>E516B-LS</b> Electrical requirements: 11.6kW, 400-415Vac, 50/60Hz, 3P+N+E, 20A			£6,390.00
<b>E516A-LS</b> Electrical requirements: 10.2kW, 400-415Vac, 50/60Hz, 3P+N+E, 15A			£6,720.00

900mm	<b>REFRIGERATED BASE, 2 x 1/1 GN DRAWERS</b>		
<b>E516D-RB</b> Electrical requirements: 14.4kW, 400-415Vac, 50/60Hz, 3P+N+E, 20A			£8,230.00
<b>E516C-RB</b> Electrical requirements: 13kW, 400-415Vac, 50/60Hz, 3P+N+E, 20A			£8,545.00
<b>E516B-RB</b> Electrical requirements: 11.6kW, 400-415Vac, 50/60Hz, 3P+N+E, 20A			£8,895.00
<b>E516A-RB</b> Electrical requirements: 10.2kW, 400-415Vac, 50/60Hz, 3P+N+E, 15A			£9,205.00

**Note:** Standard machined finish smooth griddle plate supplied.

**Choice of griddle surfaces:** Simply order the optional griddle plate model number and unit is supplied with your nominated surface. View options page 15.

## ELECTRIC COOKTOPS

Model	Description	Price (exc. VAT)
300mm	<b>OPTIONAL GRIDDLE PLATE SURFACE</b>	
<b>PE312R3*</b>	300mm x 12mm Griddle plate – ribbed full	£1,225.00

600mm	<b>OPTIONAL GRIDDLE PLATE SURFACE</b>	
<b>PE612R3*</b>	600mm x 12mm Griddle plate – ribbed 300mm RH	£1,400.00
<b>PE612R6*</b>	600mm x 12mm Griddle plate – ribbed full	£2,045.00

900mm	<b>OPTIONAL GRIDDLE PLATE SURFACE</b>	
<b>PE912R3*</b>	900mm x 12mm Griddle plate – ribbed 300mm RH	£1,865.00
<b>PE912R5*</b>	900mm x 12mm Griddle plate – ribbed 450mm RH	£2,145.00
<b>PE912R9*</b>	900mm x 12mm Griddle plate – ribbed full	£3,105.00

### OPTIONAL EXTRAS ELECTRIC COOKTOPS

<b>228807</b>	Mobile castor kit ( 2 lockable)	£150.00
<b>013600</b>	Solid cast element	£300.00

**Note:** The standard plate is not included when ordering an optional griddle plate surface.

\*Options must be specified at the placement of order.

## ELECTRIC INDUCTION COOKTOPS



- High performance 450mm and 900mm Induction Cooktops and Oven Ranges
- 6mm thick ceramic glass cooking surface
- Fully modular with adjustable feet for match suite finish
- 270mm diameter induction zones or full area
- Infinitely variable power controls for each induction zone
- Automatic pan detection switches cooking zone off when a pan is removed
- Heating ON indicator lights (green) including pan detection indication
- Fully sealed cooking surface
- Removable full stainless steel air intake filters (induction cooling)
- Front service access



IN511F-B















IN512R5-LS



IN514F-LS

# ELECTRIC INDUCTION COOKTOPS

## ELECTRIC INDUCTION COOKTOPS OVERVIEW

INDUCTION CODES	INDUCTION ZONE CONFIGURATIONS		
	450mm - 1 zone	450mm - 2 zones	900mm - 4 zones
 <b>F</b> - Full area induction			
 <b>R3</b> - 3.5kW round induction			
 <b>R5</b> - 5kW round induction			
<b>R3F/R5F</b> - 2 round 2 full area zones			

Model	Hob Options	Dimensions	Price (exc. VAT)
-------	-------------	------------	------------------



### 450mm INDUCTION COOKTOPS

### SINGLE FULL AREA ZONE - BENCH MODEL



#### IN511F-B

Electrical requirements:  
5.0kW, 400-415V, 50/60Hz,  
3P+E, 7A

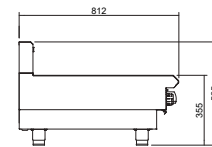
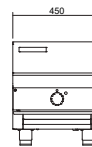

£7,750.00

#### IN511F-B



### 450mm INDUCTION COOKTOPS

### SINGLE FULL AREA ZONE - CABINET BASE (RACKING KIT NOT INCLUDED)



#### IN511F-CB

Electrical requirements:  
5.0kW, 400-415V, 50/60Hz,  
3P+E, 7A

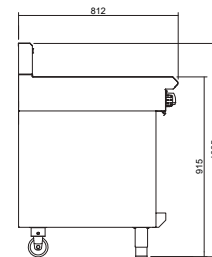
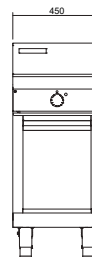

£8,450.00



#### IN511F-CB

Model	Description	Price (exc. VAT)
-------	-------------	------------------



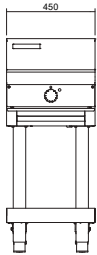
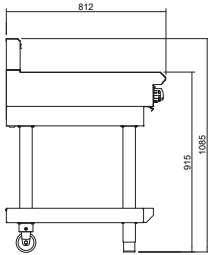

### OPTIONAL CABINET BASE GASTRONORM RACKING KIT

228791	Gastronorm racking kit 1/1 GN/4 position/450mm/550mm Cabinet Base	£275.00 (per kit)
--------	---	----------------------



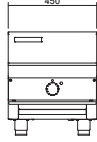
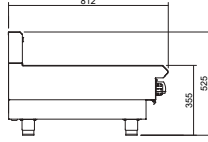

# ELECTRIC INDUCTION COOKTOPS

	Model	Hob Options	Dimensions	Price (exc. VAT)
 	450mm INDUCTION COOKTOPS		<b>SINGLE FULL AREA ZONE - LEG STAND</b>	
	<b>IN511F-LS</b>	 Electrical requirements: 5.0kW, 400-415V, 50/60Hz, 3P+E, 7A	 	£8,085.00

IN511F-LS

 	450mm INDUCTION COOKTOPS		<b>SINGLE ROUND ZONE - BENCH MODEL</b>	
	<b>IN511R3-B</b>	 Electrical requirements: 3.5kW, 230-240V, 50/60Hz, 1P+N+E, 15A	 	£6,315.00
<b>IN511R5-B</b>	 Electrical requirements: 5.0kW, 400-415V, 50/60Hz, 3P+E, 7A			£6,350.00

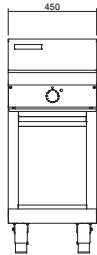
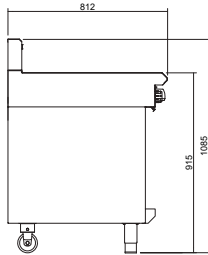
IN511R3-B





 	450mm INDUCTION COOKTOPS		<b>SINGLE ROUND ZONE - CABINET BASE (RACKING KIT NOT INCLUDED)</b>	
	<b>IN511R3-CB</b>	 Electrical requirements: 3.5kW, 230-240V, 50/60Hz, 1P+N+E, 15A	 	£7,010.00
<b>IN511R5-CB</b>	 Electrical requirements: 5.0kW, 400-415V, 50/60Hz, 3P+E, 7A			£7,010.00

IN511R3-CB

Model	Description	Price (exc. VAT)
-------	-------------	------------------

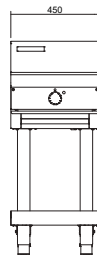
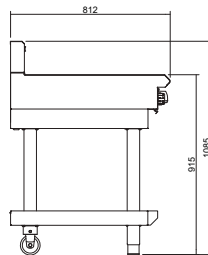

## OPTIONAL CABINET BASE GASTRONORM RACKING KIT

<b>228791</b>	Gastronorm racking kit 1/1 GN/4 position/450mm/550mm Cabinet Base	£275.00 (per kit)
---------------	---	-------------------



	Model	Hob Options	Dimensions	Price (exc. VAT)
 	450mm INDUCTION COOKTOPS		<b>SINGLE ROUND ZONE - LEG STAND</b>	
	<b>IN511R3-LS</b>	 Electrical requirements: 3.5kW, 230-240V, 50/60Hz, 1P+N+E, 15A	 	£6,650.00
<b>IN511R5-LS</b>	 Electrical requirements: 5.0kW, 400-415V, 50/60Hz, 3P+E, 7A			£6,680.00

IN511R3-LS

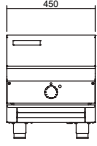
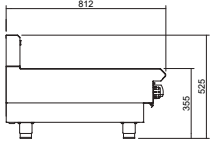
# ELECTRIC INDUCTION COOKTOPS

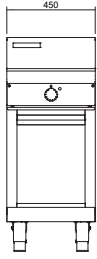
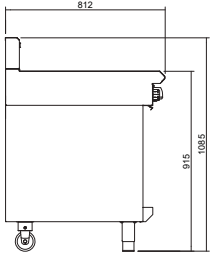

Model	Hob Options	Dimensions	Price (exc. VAT)
450mm INDUCTION COOKTOPS		<b>2 FULL AREA ZONES - BENCH MODEL</b>	
 	<b>IN512F-B</b> Electrical requirements: 10kW, 400-415V, 50/60Hz, 3P+E, 14A	  	£9,005.00

IN512F-B



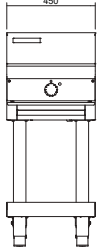
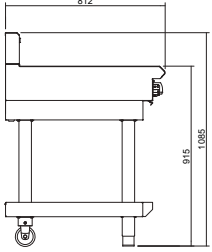

Model	Hob Options	Dimensions	Price (exc. VAT)
450mm INDUCTION COOKTOPS		<b>2 FULL AREA ZONES - CABINET BASE (RACKING KIT NOT INCLUDED)</b>	
 	<b>IN512F-CB</b> Electrical requirements: 10kW, 400-415V, 50/60Hz, 3P+E, 14A	  	£9,705.00

IN512F-CB

Model	Description	Price (exc. VAT)
<b>OPTIONAL CABINET BASE GASTRONORM RACKING KIT</b>		
228791	Gastronorm racking kit 1/1 GN/4 position/450mm/550mm Cabinet Base	£275.00 (per kit)

Model	Hob Options	Dimensions	Price (exc. VAT)
450mm INDUCTION COOKTOPS		<b>2 FULL AREA ZONES - LEG STAND</b>	
 	<b>IN512F-LS</b> Electrical requirements: 10kW, 400-415V, 50/60Hz, 3P+E, 14A	  	£9,335.00

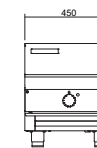
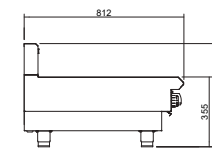
IN512F-LS

Model	Hob Options	Dimensions	Price (exc. VAT)
450mm INDUCTION COOKTOPS		<b>2 ROUND ZONES - BENCH MODEL</b>	
 	<b>IN512R3-B</b> Electrical requirements: 7kW, 400-415V, 50/60Hz, 3P+E, 10A	  	£8,045.00
	<b>IN512R5-B</b> Electrical requirements: 10kW, 400-415V, 50/60Hz, 3P+E, 14A		

IN512R3-B

# ELECTRIC INDUCTION COOKTOPS

Model	Hob Options	Dimensions	Price (exc. VAT)
-------	-------------	------------	------------------



## 450mm INDUCTION COOKTOPS

### 2 ROUND ZONES - CABINET BASE (RACKING KIT NOT INCLUDED)



IN512R3-CB

#### IN512R3-CB

Electrical requirements:  
7.0kW, 400-415V, 50/60Hz,  
3P+E, 10A

#### IN512R5-CB

Electrical requirements:  
10kW, 400-415V, 50/60Hz,  
3P+E, 14A

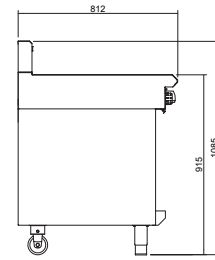
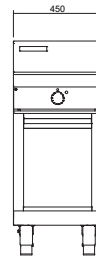

£8,750.00

£8,565.00

Model	Description	Price (exc. VAT)
-------	-------------	------------------

### OPTIONAL CABINET BASE GASTRONORM RACKING KIT

228791	Gastronorm racking kit 1/1 GN/4 position/450mm/550mm Cabinet Base	£275.00 (per kit)
--------	---	-------------------

Model	Hob Options	Dimensions	Price (exc. VAT)
-------	-------------	------------	------------------



## 450mm INDUCTION COOKTOPS

### 2 ROUND ZONES - LEG STAND



IN512R3-LS

#### IN512R3-LS

Electrical requirements:  
7.0kW, 400-415V, 50/60Hz,  
3P+E, 10A

#### IN512R5-LS

Electrical requirements:  
10kW, 400-415V, 50/60Hz,  
3P+E, 14A

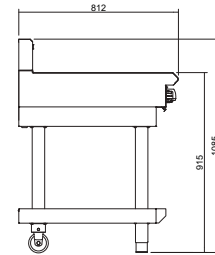
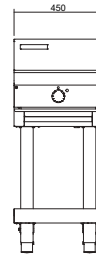

£8,375.00

£8,200.00



## 900mm INDUCTION COOKTOPS

### 4 FULL AREA ZONES - BENCH MODEL



IN514F-B

#### IN514F-B

Electrical requirements:  
20kW, 400-415V, 50/60Hz,  
3P+E, 28A

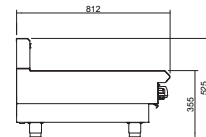
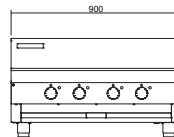

£16,860.00



## 900mm INDUCTION COOKTOPS

### 4 FULL AREA ZONES - CABINET BASE (RACKING KIT NOT INCLUDED)



IN514F-CB

#### IN514F-CB

Electrical requirements:  
20kW, 400-415V, 50/60Hz,  
3P+E, 28A

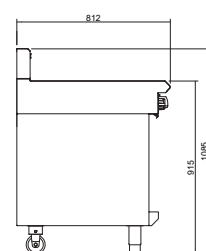
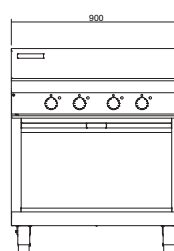

£17,820.00

# ELECTRIC INDUCTION COOKTOPS

Model	Description	Price (exc. VAT)
<b>OPTIONAL CABINET BASE GASTRONORM RACKING KIT</b>		
<b>237393</b>	Gastronorm racking kit 1/1 GN/4 position/600mm/700mm/900mm/1200mm Cabinet Base. Accommodates 1 or 2 Racking Kits	<b>£275.00 (per kit)</b>

Model	Hob Options	Dimensions	Price (exc. VAT)
-------	-------------	------------	------------------



## 900mm INDUCTION COOKTOPS

## 4 FULL AREA ZONES - LEG STAND



**IN514F-LS**

**IN514F-LS**

Electrical requirements:  
20kW, 400-415V, 50/60Hz,  
3P+E, 28A

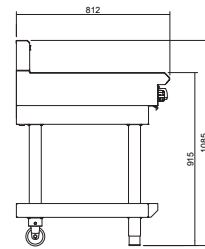
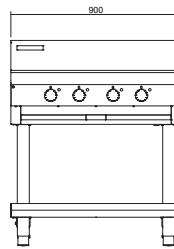

**£17,300.00**



## 900mm INDUCTION COOKTOPS

## 4 ROUND ZONES - BENCH MODEL



**IN514R3-B**

**IN514R3-B**

Electrical requirements:  
14kW, 400-415V, 50/60Hz,  
3P+E, 20A

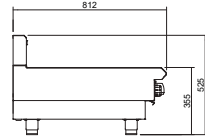
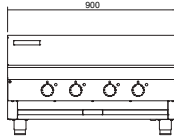

**£15,130.00**

**IN514R5-B**

Electrical requirements:  
20kW, 400-415V, 50/60Hz,  
3P+E, 28A



**£14,870.00**



## 900mm INDUCTION COOKTOPS

## 4 ROUND ZONES - CABINET BASE (RACKING KIT NOT INCLUDED)



**IN514R3-CB**

**IN514R3-CB**

Electrical requirements:  
14kW, 400-415V, 50/60Hz,  
3P+E, 20A

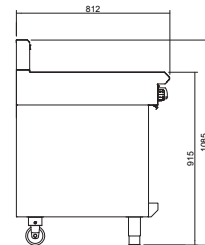
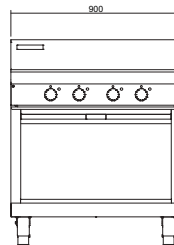

**£16,085.00**

**IN514R5-CB**

Electrical requirements:  
20kW, 400-415V, 50/60Hz,  
3P+E, 28A



**£15,830.00**



## 900mm INDUCTION COOKTOPS

## 4 ROUND ZONES - LEG STAND



**IN514R3-LS**

**IN514R3-LS**

Electrical requirements:  
14kW, 400-415V, 50/60Hz,  
3P+E, 20A

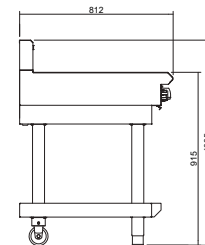
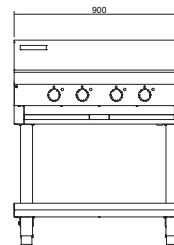

**£15,575.00**

**IN514R5-LS**

Electrical requirements:  
20kW, 400-415V, 50/60Hz,  
3P+E, 28A











**£15,225.00**

Model	Description	Price (exc. VAT)
<b>OPTIONAL CABINET BASE GASTRONORM RACKING KIT</b>		
<b>237393</b>	Gastronorm racking kit 1/1 GN/4 position/600mm/700mm/900mm/1200mm Cabinet Base. Accommodates 1 or 2 Racking Kits	<b>£275.00 (per kit)</b>

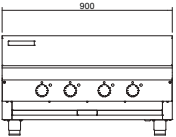

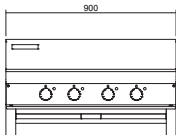

# ELECTRIC INDUCTION COOKTOPS

## MIXED ZONE INDUCTION HOBS - SPECIAL ORDER ONLY

Model	Hob Options	Dimensions	Price (exc. VAT)
900mm INDUCTION COOKTOPS		<b>2 ROUND/2 FULL AREA ZONES - BENCH MODEL</b>	
  <p><b>IN514R3F-B</b> Electrical requirements: 17kW, 400-415V, 50/60Hz, 3P+E, 24A</p>	  		£16,160.00
			<p><b>IN514R5F-B</b> Electrical requirements: 20kW, 400-415V, 50/60Hz, 3P+E, 28A</p>
<p><b>Note:</b> Full area induction on LH side and round induction on RH side available to order.</p>			

Model	Hob Options	Dimensions	Price (exc. VAT)
900mm INDUCTION COOKTOPS		<b>2 ROUND/2 FULL AREA ZONES - CABINET BASE (RACKING KIT NOT INCLUDED)</b>	
  <p><b>IN514R3F-CB</b> Electrical requirements: 17kW, 400-415V, 50/60Hz, 3P+E, 24A</p>	  		£17,125.00
			<p><b>IN514R5F-CB</b> Electrical requirements: 20kW, 400-415V, 50/60Hz, 3P+E, 28A</p>
<p><b>Note:</b> Full area induction on LH side and round induction on RH side available to order.</p>			

Model	Description	Price (exc. VAT)
<b>OPTIONAL CABINET BASE GASTRONORM RACKING KIT</b>		
<b>237393</b>	Gastronorm racking kit 1/1 GN/4 position/600mm/700mm/900mm/1200mm Cabinet Base. Accommodates 1 or 2 Racking Kits	£275.00 (per kit)

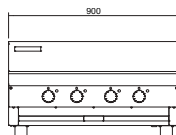
Model	Hob Options	Dimensions	Price (exc. VAT)
900mm INDUCTION COOKTOPS		<b>2 ROUND/2 FULL AREA ZONES - LEG STAND</b>	
  <p><b>IN514R3F-LS</b> Electrical requirements: 17kW, 400-415V, 50/60Hz, 3P+E, 24A</p>	  		£16,605.00
			<p><b>IN514R5F-LS</b> Electrical requirements: 20kW, 400-415V, 50/60Hz, 3P+E, 28A</p>
<p><b>Note:</b> Full area induction on LH side and round induction on RH side available to order.</p>			

Model	Description	Price (exc. VAT)
<b>OPTIONAL EXTRAS - ELECTRIC INDUCTION COOKTOPS</b>		
<b>228807</b>	Mobile castor kit (set of 2 lockable castors)	£150.00

# ELECTRIC INDUCTION RANGES

Model	Hob Options	Dimensions	Price (exc. VAT)
-------	-------------	------------	------------------



**IN54F**

900mm INDUCTION RANGE

**CONVECTION OVEN - 4 FULL AREA ZONES - 2/1 GN**

**IN54F**

Electrical requirements:  
26.1kW, 400-415V,  
50/60Hz, 3P+N+E, 36.3A

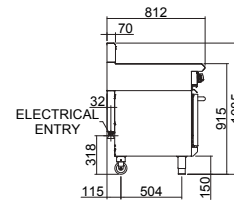
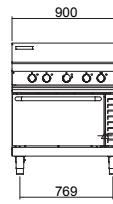

£21,065.00



**IN54R3**

900mm INDUCTION RANGE

**CONVECTION OVEN - 4 ROUND ZONES - 2/1 GN**

**IN54R3**

Electrical requirements:  
20.1kW, 400-415V,  
50/60Hz, 3P+N+E, 28.5A

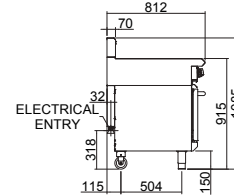
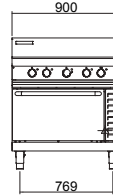

£19,585.00

**IN54R5**

Electrical requirements:  
26.1kW, 400-415V,  
50/60Hz, 3P+N+E, 36.3A



£19,935.00





Model	Description	Price (exc. VAT)
-------	-------------	------------------





<b>227896</b>	Oven rack to suit 900mm/1200mm 2/1 GN oven range	£95.00
<b>228807</b>	Mobile castor kit (set of 2 lockable castors)	£150.00

Note: Options must be specified at the time of order

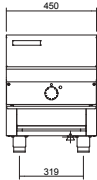
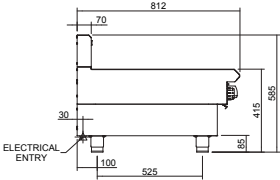

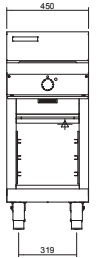
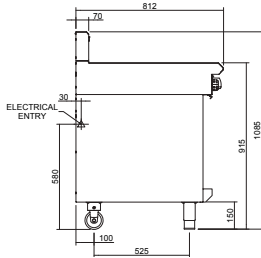

# ELECTRIC INDUCTION COOKTOPS

# ELECTRIC INDUCTION WOKS

Model	Hob Options	Dimensions	Price (exc. VAT)
450mm INDUCTION WOKS			
<b>SINGLE WORK ZONE - BENCH MODEL</b>			
  <p><b>IN511W3-B</b> Electrical requirements: 3.5kW, 220-240V, 50/60Hz, 1P+N+E, 16A</p>	  	 	£6,550.00
			<p><b>IN511W5-B</b> Electrical requirements: 5kW, 400-415V, 50/60Hz, 3P+E, 24A</p>



Model	Hob Options	Dimensions	Price (exc. VAT)
450mm INDUCTION WOKS			
<b>SINGLE WORK ZONE - CABINET BASE (RACKING KIT NOT INCLUDED)</b>			
  <p><b>IN511W3-CB</b> Electrical requirements: 3.5kW, 220-240V, 50/60Hz, 1P+N+E, 16A</p>	  	 	£7,125.00
			<p><b>IN511W5-CB</b> Electrical requirements: 5kW, 400-415V, 50/60Hz, 3P+E, 24A</p>

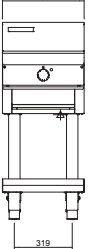
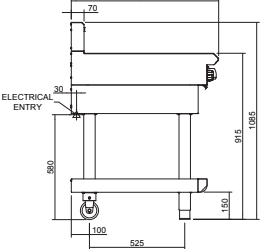

Model	Description	Price (exc. VAT)
<b>OPTIONAL CABINET BASE GASTRONORM RACKING KIT</b>		
<b>228791</b>	Gastronorm racking kit 1/1 GN/4 position/450mm/550 Cabinet Base	£275.00 (per kit)

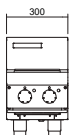
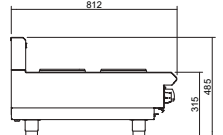

Model	Hob Options	Dimensions	Price (exc. VAT)
450mm INDUCTION WOKS			
<b>SINGLE WORK ZONE - LEG STAND</b>			
  <p><b>IN511W3-LS</b> Electrical requirements: 3.5kW, 220-240V, 50/60Hz, 1P+N+E, 16A</p>	  	 	£6,885.00
			<p><b>IN511W5-LS</b> Electrical requirements: 5kW, 400-415V, 50/60Hz, 3P+E, 24A</p>

Model	Description	Price (exc. VAT)
<b>OPTIONAL EXTRAS - ELECTRIC INDUCTION WOKS</b>		
<b>228807</b>	Mobile castor kit (set of 2 lockable castors)	£150.00

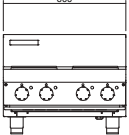
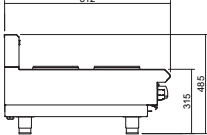

# NEW ELECTRIC SEALED HOBS

Model	Hob Options	Dimensions	Price (exc. VAT)
<b>300mm SEALED HOB</b> <b>E512S-B</b> Electrical requirements: 5.2kW, 400-415V, 50/60Hz, 1P+N+E, 22A		<b>COOKTOP SEALED HOB - BENCH MODEL</b> ⚡    	
<b>E512S-B</b>		£2,255.00	

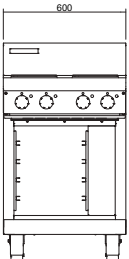
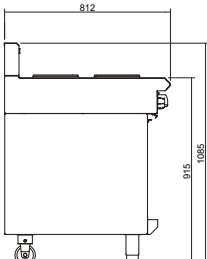
<b>600mm SEALED HOB</b> <b>E514S-B</b> Electrical requirements: 10.4kW, 400-415Vac, 50/60Hz, 2P+N+E, 22A		<b>COOKTOP SEALED HOB - BENCH MODEL</b> ⚡    	
<b>E514S-B</b>		£3,620.00	

<b>600mm SEALED HOB</b> <b>E514S-CB</b> Electrical requirements: 10.4kW, 400-415V, 50/60Hz, 2P+N+E, 22A		<b>COOKTOP SEALED HOB - CABINET BASE (RACKING KIT NOT INCLUDED)</b> ⚡    	
<b>E514S-CB</b>		£4,395.00	

Model	Description	Price (exc. VAT)
<b>OPTIONAL CABINET BASE GASTRONORM RACKING KIT</b>		
<b>237393</b>	Gastronorm racking kit 1/1 GN/4 position/600mm/700mm/900mm/1200mm Cabinet Base. Accommodates 1 or 2 Racking Kits	<b>£275.00</b> (per kit)

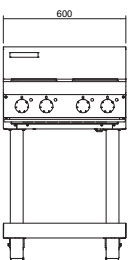
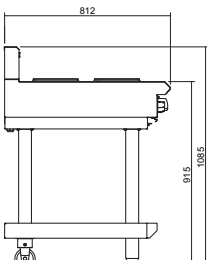
Model	Hob Options	Dimensions	Price (exc. VAT)
<b>600mm SEALED HOB</b> <b>E514S-LS</b> Electrical requirements: 10.4kW, 400-415V, 50/60Hz, 2P+N+E, 22A		<b>COOKTOP SEALED HOB - LEG STAND</b> ⚡    	
<b>E514S-LS</b>		£3,990.00	

# NEW ELECTRIC SEALED HOBS

Model	Hob Options	Dimensions	Price (exc. VAT)
-------	-------------	------------	------------------



E516S-B

900mm SEALED HOB

**E516S-B**

Electrical requirements:  
15.6kW, 400-415V,  
50/60Hz, 3P+N+E, 22A



COOKTOP SEALED HOB - BENCH MODEL

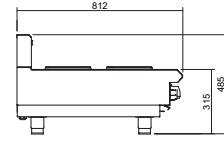
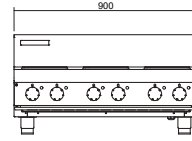

£4,950.00



E516S-CB

900mm SEALED HOB

**E516S-CB**

Electrical requirements:  
15.6kW, 400-415V,  
50/60Hz, 3P+N+E, 22A



COOKTOP SEALED HOB - CABINET BASE  
(RACKING KIT NOT INCLUDED)

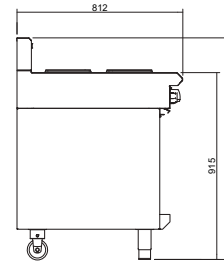
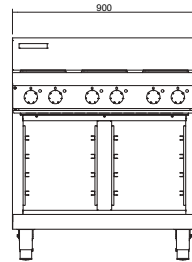

£5,870.00

Model	Description	Price (exc. VAT)
-------	-------------	------------------

## OPTIONAL CABINET BASE GASTRONORM RACKING KIT

237393	Gastronorm racking kit 1/1 GN/4 position/600mm/700mm/900mm/1200mm Cabinet Base. Accommodates 1 or 2 Racking Kits	£275.00 (per kit)
--------	--	----------------------

Model	Hob Options	Dimensions	Price (exc. VAT)
-------	-------------	------------	------------------



E516S-LS

900mm SEALED HOB

**E516S-LS**

Electrical requirements:  
15.6kW, 400-415V,  
50/60Hz, 3P+N+E, 22A



COOKTOP SEALED HOB - LEG STAND

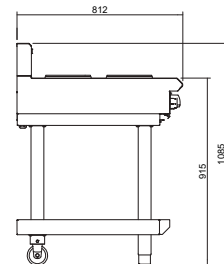
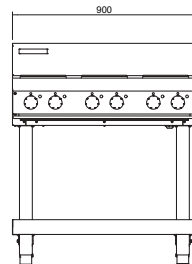

£5,390.00



E516S-RB

900mm SEALED HOB

**E516S-RB**

Electrical requirements:  
15.6kW, 400-415V,  
50/60Hz, 3P+N+E, 22A



COOKTOP SEALED HOB - REFRIGERATED  
BASE, 2 X 1/1 GN DRAWERS

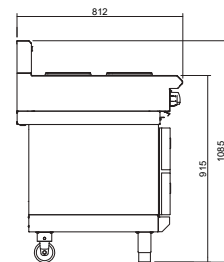
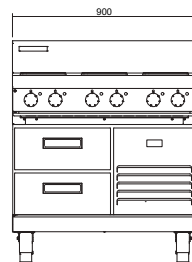

£11,550.00

**RB Electrical requirements:**

0.5kW, 220-240V,  
50Hz, 1.8A, 1P+N+E  
10A Cordset fitted

# NEW ELECTRIC SEALED HOB OVEN RANGE

Model	Hob/Oven Options	Dimensions	Price (exc. VAT)
-------	------------------	------------	------------------



E506S

## 900mm SEALED HOB

### E506S

Electrical requirements:  
22.1kW, 400-415V,  
50/60Hz, 3P+N+E



## SEALED HOBS STATIC OVEN - 2/1 GN

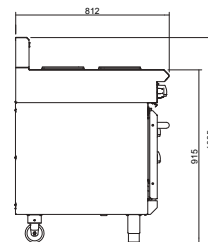
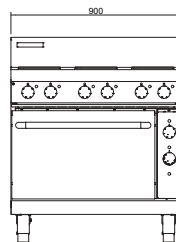

£8,045.00



E56S

## 900mm SEALED HOB

### E56S

Electrical requirements:  
22.2kW, 400-415V,  
50/60Hz, 3P+N+E



## SEALED HOBS CONVECTION OVEN - 2/1 GN

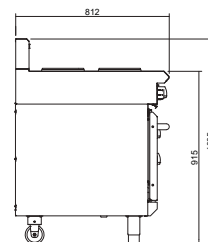
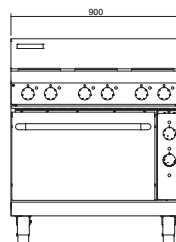

£8,595.00

Model	Description	Price (exc. VAT)
-------	-------------	------------------

## OPTIONAL EXTRAS - ELECTRIC OVEN RANGES

227896	Oven rack to suit E506D series	£95.00
228807	Mobile castor kit (set of 2 lockable castors)	£150.00

# BLUE SEAL EVOLUTION SERIES®

Whatever the scale of operation, Blue Seal Evolution Series Oven Ranges have a gas or electric option to suit. Gas options come equipped with our 7kW open cooktop burners, while the electric versions offer a choice of heavy-duty 2.4kW radiant elements, or 2kW solid plates.

Within the oven itself, cast iron sole plates ensure even heat distribution. Heavy-duty motors and circulation fans in the convection ovens reduce cooking times and enable food to be cooked at Lower temperatures.

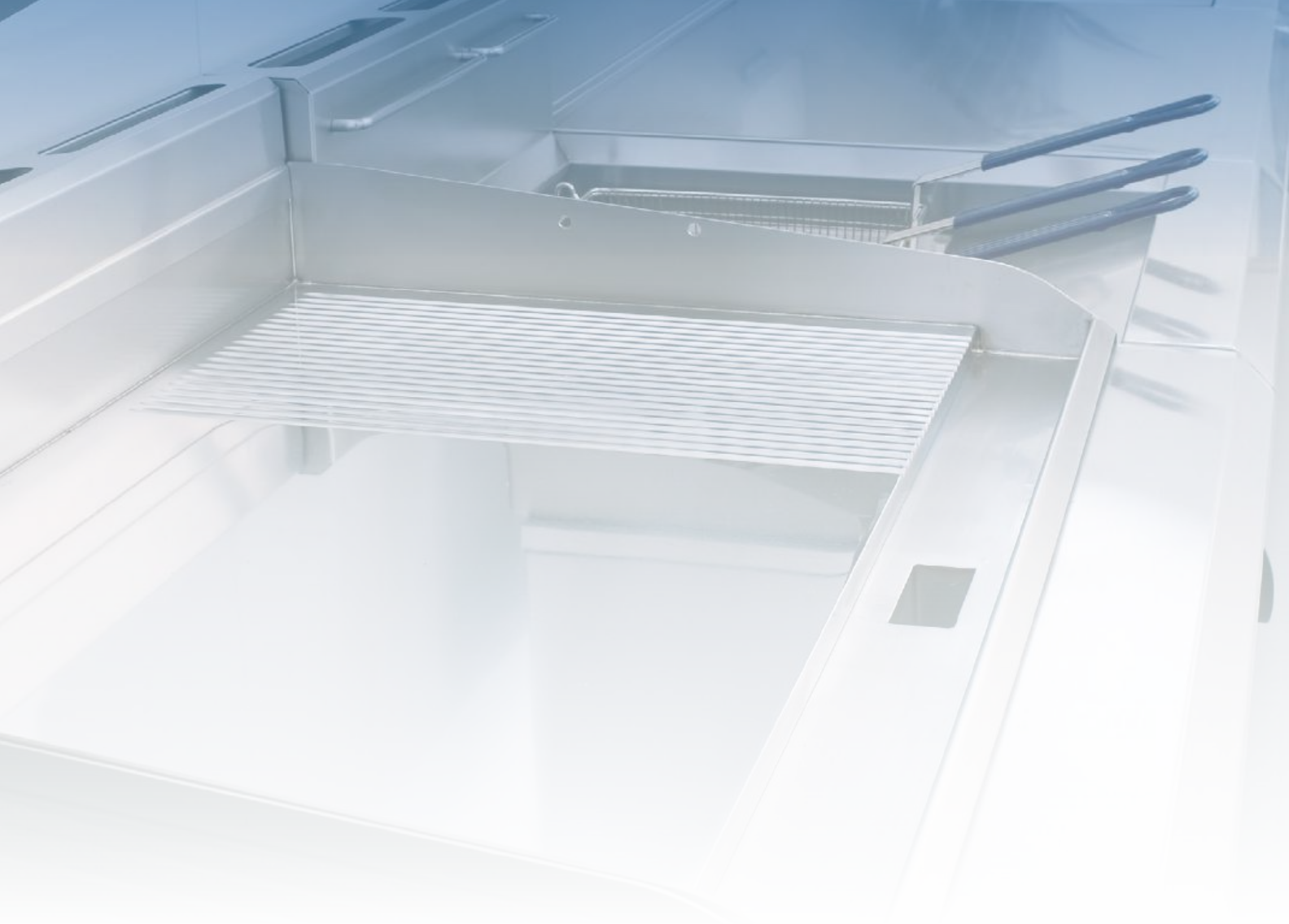

**Refrigerated Units** - Chill where you cook. The inclusion of refrigeration units into the cooking line means raw materials can be safely stored nearby.

**Ease of cleaning** - The 3mm splashguard is a fully welded hob surround providing extra durability and ease of cleaning

**Accurate Temperature Control** - Heavy-duty control knobs with strengthened shafts are designed to last. Non-fade temperature markings provide accurate heat settings for more consistent results.

**Target Tops** - Delivering power where you need it. Heat is delivered by a 12.5kW dual ring, cast iron burner, with single control.



It's all about power, performance and choice.

# GAS OVEN RANGES

Model	Hob Options	Dimensions	Gas Power kW	Price (exc. VAT)
-------	-------------	------------	--------------	------------------



**G504D**

## 600mm GAS RANGE

## STATIC OVEN - 1/1 GN



<b>G504D</b>			37.7	£3,915.00
<b>G504C</b>			27.8	£4,240.00
<b>G504B</b>			17.8	£4,600.00



**G505D**

## 750mm GAS RANGE

## STATIC OVEN - 1/1



<b>G505D</b>			37	£4,285.00
<b>G505C</b>			29	£4,630.00



**G54C**

## 750mm GAS RANGE

## CONVECTION OVEN - 1/1



<b>G54D</b>			37	£6,750.00
<b>G54C</b>			29	£7,075.00

**Electrical requirements:**  
0.13kW, 230-240Vac,  
50/60Hz, 1P+N+E, 0.6A  
3 PIN, 13A Cordset fitted



**GE505D**

## 750mm GAS RANGE

## ELECTRIC STATIC OVEN - 1/1 GN



<b>GE505D</b>			28	£6,330.00
<b>GE505C</b>			20	£6,670.00

**Electrical requirements:**  
5.5kW, 230-240Vac,  
50/60Hz, 1P+N+E, 23A standard  
or 5.5kW, 400-415Vac, 50/60Hz,  
3P+N+E, 8A

**Note:** Flame failure standard on open burners. Standard machined finish smooth griddle plate supplied.

**Choice of griddle surfaces:** Simply order the optional griddle plate model number and unit is supplied with your nominated surface. View options page 33.

# GAS OVEN RANGES

Model	Hob Options	Dimensions	Gas Power kW	Price (exc. VAT)
-------	-------------	------------	--------------	------------------



GE54D

## 750mm GAS RANGE

GE54D



GE54C



### Electrical requirements:

5.6kW, 230-240Vac,  
50/60Hz, 1P+N+E, 23.3A  
standard or 5.6kW, 400-415Vac,  
50/60Hz, 3P+N+E, 8A

## ELECTRIC CONVECTION OVEN - 1/1 GN

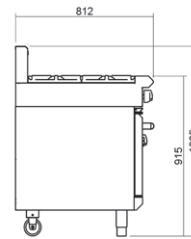
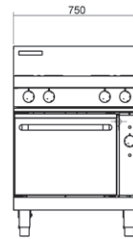

28

£7,550.00

20

£7,915.00



**Note:** Flame failure standard on open burners. Standard machined finish smooth griddle plate supplied.

**Choice of griddle surfaces:** Simply order the optional griddle plate model number and unit is supplied with your nominated surface. View options page 33.

# GAS OVEN RANGES

Model	Hob Options	Dimensions	Gas Power kW	Price (exc. VAT)
900mm GAS RANGE		STATIC OVEN - 2/1 GN		
<b>G506D</b>			51	£4,210.00
<b>G506C</b>			43	£4,550.00
<b>G506B</b>			35	£4,885.00
<b>G506A</b>			27	£5,210.00

**G506D**



Model	Hob Options	Dimensions	Gas Power kW	Price (exc. VAT)
900mm GAS RANGE		CONVECTION OVEN - 2/1		
<b>G56D</b>			51	£8,185.00
<b>G56C</b>			43	£8,505.00
<b>G56B</b>			35	£8,840.00
<b>G56A</b>			27	£9,180.00
<b>Electrical requirements:</b>				
0.13kW, 230-240Vac, 50/60Hz, 1P+N+E, 0.6A 3 PIN, 13A Cordset fitted				

**G56D**



Model	Hob Options	Dimensions	Gas Power kW	Price (exc. VAT)
900mm GAS RANGE		ELECTRIC STATIC OVEN - 2/1		
<b>GE506D</b>			42	£6,840.00
<b>GE506C</b>			34	£7,170.00
<b>GE506B</b>			26	£7,495.00
<b>GE506A</b>			18	£7,825.00
<b>Electrical requirements:</b>				
Standard Supply 6.5kW, 230-240Vac, 50/60Hz, 1P+N+E, 27A standard or 6.5kW, 400-415Vac, 50/60Hz, 3P+N+E, 10A				

**GE506D**



Model	Hob Options	Dimensions	Gas Power kW	Price (exc. VAT)
900mm GAS RANGE		ELECTRIC CONVECTION OVEN - 2/1GN		
<b>GE56D</b>			42	£10,065.00
<b>GE56C</b>			34	£10,420.00
<b>GE56B</b>			26	£10,745.00
<b>GE56A</b>			18	£11,085.00
<b>Electrical requirements:</b>				
Standard Supply 6.6kW, 230-240Vac, 50/60Hz, 1P+N+E, 27.7A standard or 6.6kW, 400-415Vac, 50/60Hz, 3P+N+E, 10A				

**GE56D**



**Note:** Flame failure standard on open burners. Standard machined finish smooth griddle plate supplied.

**Choice of griddle surfaces:** Simply order the optional griddle plate model number and unit is supplied with your nominated surface. View options page 33.

# GAS OVEN RANGES

Model	Hob Options	Dimensions	Gas Power kW	Price (exc. VAT)
-------	-------------	------------	--------------	------------------



G508D

## 1200mm GAS RANGE

## STATIC OVEN - 2/1 GN



G508D				65	£6,930.00
G508C				57	£7,265.00
G508B				49	£7,585.00
G508A				41	£7,935.00



G58D

## 1200mm GAS RANGE

## CONVECTION OVEN - 2/1



G58D				65	£9,870.00
G58C				57	£10,185.00
G58B				49	£10,535.00
G58A				41	£10,865.00

Electrical requirements:  
0.13kW, 230-240Vac,  
50/60Hz, 1P+N+E, 0.6A  
3 PIN, 13A Cordset fitted



GE508D

## 1200mm GAS RANGE

## ELECTRIC STATIC OVEN - 2/1



GE508D				56	£8,075.00
GE508C				48	£8,415.00
GE508B				40	£8,760.00
GE508A				24	£9,085.00

Electrical requirements:  
Standard Supply  
6.5kW, 230-240Vac,  
50/60Hz, 1P+N+E, 27A standard  
or 6.5kW, 400-415Vac, 50/60Hz,  
3P+N+E, 10A



GE58D

## 1200mm GAS RANGE

## ELECTRIC CONVECTION OVEN - 2/1 GN



GE58D				56	£10,900.00
GE58C				48	£11,245.00
GE58B				40	£11,580.00
GE58A				24	£11,925.00

Electrical requirements:  
Standard Supply  
6.6kW, 230-240Vac,  
50/60Hz, 1P+N+E, 27.7A standard  
or 6.6kW, 400-415Vac, 50/60Hz,  
3P+N+E, 10A

Note: Flame failure standard on open burners. Standard machined finish smooth griddle plate supplied.

Choice of griddle surfaces: Simply order the optional griddle plate model number and unit is supplied with your nominated surface. View options page 33.

## GAS DOUBLE OVEN RANGES



G528D

Model	Hob Options	Dimensions	Gas Power kW	Price (exc. VAT)
1200mm GAS RANGE		DOUBLE STATIC OVEN - 2 x 1/1 GN		
G528D			69.2	£8,750.00
G528C			61.2	£9,065.00
G528B			53.2	£9,410.00
G528A			45.2	£9,730.00

**Note:** Flame failure standard on open burners. Standard machined finish smooth griddle plate supplied.  
**Choice of griddle surfaces:** Simply order the optional griddle plate model number and unit is supplied with your nominated surface. View options below.

Model	Description	Price (exc. VAT)
300mm	<b>OPTIONAL GRIDDLE PLATE SURFACE</b>	
PG312R3*	300mm x 12mm Griddle plate – ribbed full	£1,155.00
600mm	<b>OPTIONAL GRIDDLE PLATE SURFACES</b>	
PG612R3*	600mm x 12mm Griddle plate – ribbed 300mm RH	£1,340.00
PG612R6*	600mm x 12mm Griddle plate – ribbed full	£1,780.00
900mm	<b>OPTIONAL GRIDDLE PLATE SURFACES</b>	
PG912R3*	900mm x 12mm Griddle plate – ribbed 300mm RH	£1,480.00
PG912R5*	900mm x 12mm Griddle plate – ribbed 450mm RH	£1,890.00
PG912R9*	900mm x 12mm Griddle plate – ribbed full	£2,940.00
900mm	<b>OPTIONAL GRIDDLE PLATE SURFACES FOR 1200mm WIDE HOBS</b>	
PG912R3*	900mm x 12mm Griddle plate – ribbed 300mm RH	£1,480.00
PG912R6*	900mm x 12mm Griddle plate – ribbed 600mm RH	£1,890.00
PG912R9*	900mm x 12mm Griddle plate – ribbed full	£2,940.00

### OPTIONAL EXTRAS GAS OVEN RANGES

227896	Oven rack for 900mm ovens	£95.00
228106	Oven rack for 600mm ovens	£90.00
228807	Mobile castor kit (set of 2 lockable)	£150.00
Flex3/4/51	Flexihose 3/4 (flexible quick coupling hose & tether chain)	£265.00
230013	Bench shield, fits LH or RH of open burners	£135.00
UKSP4	Splashback, overshelf for 4 burner ranges	£725.00
UKSP6	Splashback, overshelf and grill shelf for 6 burner ranges	£725.00
UKSP8	Splashback, overshelf for 8 burner range	£725.00

**Note:** The standard plate is not included when ordering an optional griddle plate surface.  
 \*Options must be specified at the placement of order.

# GAS TARGET TOPS

Model	Dimensions	Gas Power kW	Price (exc. VAT)
-------	------------	--------------	------------------



900mm TARGET TOP

**BENCH MODEL**



**G57-B**

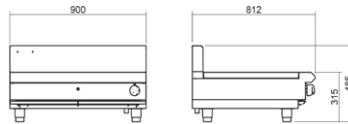

12.5

£4,645.00

**G57-B**



900mm TARGET TOP

**CABINET BASE (RACKING KIT NOT INCLUDED)**



**G57-CB**

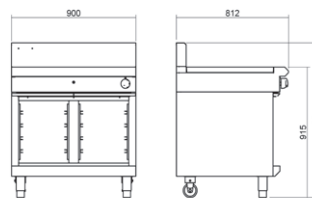

12.5

£5,685.00

**G57-CB**

**OPTIONAL**

228791 Gastronorm racking kit 1/1 GN / 4 position / 900mm Cabinet Base £275.00  
Accommodates 1 or 2 Racking Kits



900mm TARGET TOP

**LEG STAND**



**G57-LS**

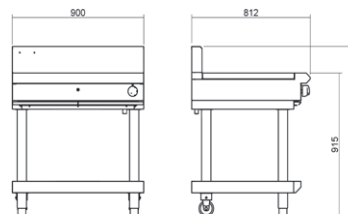

12.5

£5,035.00

**G57-LS**



900mm TARGET TOP

**REFRIGERATED BASE, 2 x 1/1 GN DRAWERS**



**G57-RB**

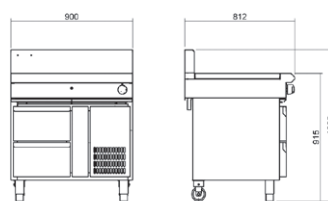

12.5













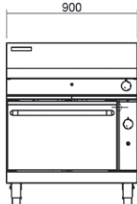
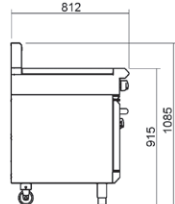

£10,065.00

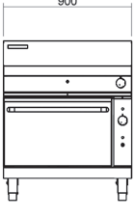
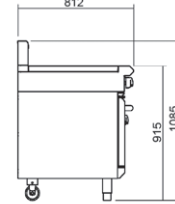
**G57-RB**

**(RB) ELECTRICAL REQUIREMENT**

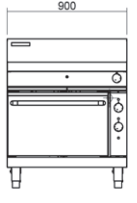
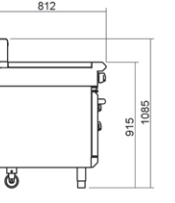
0.5kW, 220-240Vac, 50Hz, 1P+N+E, 1.8A 3 PIN,  
13A Cordset fitted

# GAS TARGET TOP OVEN RANGES

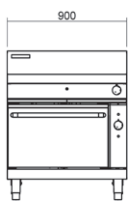
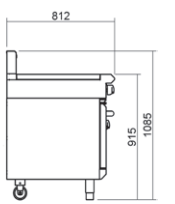
Model	Dimensions	Gas Power kW	Price (exc. VAT)
900mm GAS TARGET TOP		STATIC OVEN RANGE – 2/1 GN  	
<b>G570</b>	 	21.5	£6,465.00
900mm GAS TARGET TOP		CONVECTION OVEN RANGE – 2/1 GN   	
<b>G576</b>	 	21.5	£8,490.00
<b>G576</b>	<b>Electrical requirements:</b> 0.13kW, 230-240Vac, 50/60Hz, 1P+N+E, 0.6A 3 PIN, 13A Cordset fitted		
900mm GAS TARGET TOP		ELECTRIC STATIC OVEN RANGE – 2/1 GN   	
<b>GE570</b>	 	12.5	£6,750.00
<b>GE570</b>	<b>Electrical requirements:</b> 6.5kW, 230-240Vac, 50/60Hz, 1P+N+E, 27A standard or 6.5kW, 400-415Vac, 50/60Hz, 3P+N+E, 10A		
900mm GAS TARGET TOP		ELECTRIC CONVECTION OVEN RANGE – 2/1 GN   	
<b>GE576</b>	 	12.5	£8,690.00
<b>GE576</b>	<b>Electrical requirements:</b> 6.5kW, 230-240Vac, 50/60Hz, 1P+N+E, 27A standard or 6.5kW, 400-415Vac, 50/60Hz, 3P+N+E, 10A		







## OPTIONAL EXTRAS

## GAS TARGET TOPS / OVEN RANGES

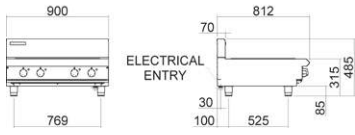
<b>227896</b>	Oven rack to suit all 6 burner oven ranges	£95.00
<b>014997</b>	Casting Hook	£80.00
<b>228807</b>	Mobile castor kit (set of 2 lockable)	£150.00
<b>Flex3/4/51</b>	Flexihose 3/4 (flexible quick coupling hose & tether chain)	£265.00

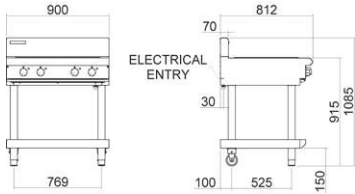
\*Options must be specified at the placement of order.

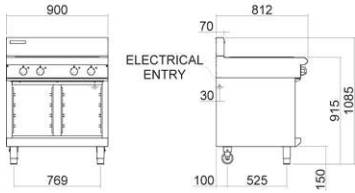
# ELECTRIC SOLID TOP HOBS

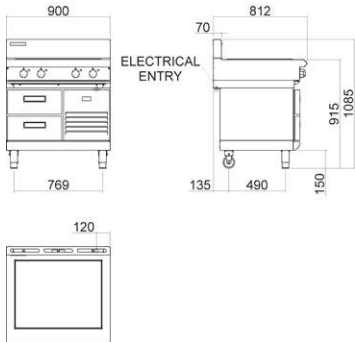
Model	Dimensions	Power kW	Price (exc. VAT)
900mm TARGET TOP   <b>BENCH MODEL</b>			
 <p><b>E57-B</b></p> <p><b>Electrical requirements:</b> 10.8kW, 400-415Vac, 50/60Hz, 3P+N+E, 1.8A , L1 22.5A, L2 13A, L3/separate 13amp</p>	 <p>900 769 812 70 30 100 525 ELECTRICAL ENTRY 315 485 85</p>	10.8	£6,090.00
900mm TARGET TOP   <b>LEG STAND MODEL</b>			
 <p><b>E57-LS</b></p> <p><b>Electrical requirements:</b> 10.8kW, 400-415Vac, 50/60Hz, 3P+N+E, 1.8A , L1 22.5A, L2 13A, L3/separate 13amp</p>	 <p>900 769 812 70 30 100 525 ELECTRICAL ENTRY 915 1085 150</p>	10.8	£6,565.00
900mm TARGET TOP   <b>CABINET BASE MODEL</b>			
 <p><b>E57-CB</b></p> <p><b>Electrical requirements:</b> 10.8kW, 400-415Vac, 50/60Hz, 3P+N+E, 1.8A , L1 22.5A, L2 13A, L3/separate 13amp</p>	 <p>900 769 812 70 30 100 525 ELECTRICAL ENTRY 915 1085 150</p>	10.8	£7,615.00
900mm TARGET TOP   <b>REFRIGERATED BASE MODEL</b>			
 <p><b>E57-RB</b></p> <p><b>Electrical requirements:</b> 10.8kW, 400-415Vac, 50/60Hz, 3P+N+E, 1.8A , L1 22.5A, L2 13A, L3/separate 13amp 220-240Vac, 50Hz, 1P+N+E, 1.8A 3-pin 10A cordset fitted for refrigerated unit</p>	 <p>900 769 812 70 30 100 525 ELECTRICAL ENTRY 915 1085 150 120 135 490</p>	10.8	£13,650.00

E57-B

E57-LS

E57-CB

E57-RB

# ELECTRIC SOLID TOP RANGES

Model	Dimensions	Power kW	Price (exc. VAT)
-------	------------	----------	------------------



900mm TARGET TOP

STATIC OVEN



**E570**

**Electrical requirements:**  
17.3kW, 400-415Vac, 50/60Hz,  
3P+N+E, 30.8A

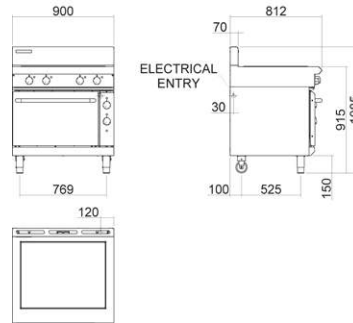

17.3

£8,400.00

**E570**



900mm TARGET TOP

CONVECTION OVEN



**E576**

**Electrical requirements:**  
17.3kW, 400-415Vac, 50/60Hz,  
3P+N+E, 30.8A

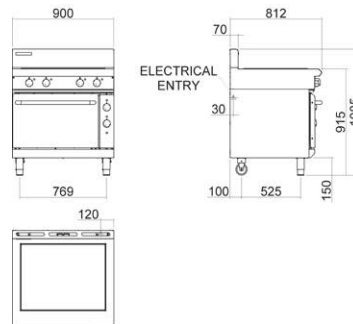

17.3

£9,450.00

**E576**

# ELECTRIC OVEN RANGES

Model	Hob Options	Dimensions	Price (exc. VAT)
<b>900mm ELECTRIC RANGE</b>		<b>STATIC OVEN - 2/1 GN</b>	
<b>E506D</b> Electrical requirements: 20.9kW, 400-415Vac, 50/60Hz, 3P+N+E			£6,490.00
<b>E506C</b> Electrical requirements: 19.5kW, 400-415Vac, 50/60Hz, 3P+N+E			£6,840.00
<b>E506B</b> Electrical requirements: 18.1kW, 400-415Vac, 50/60Hz, 3P+N+E			£7,170.00
<b>E506A</b> Electrical requirements: 16.7kW, 400-415Vac, 50/60Hz, 3P+N+E			£7,495.00



E506D

Model	Hob Options	Dimensions	Price (exc. VAT)
<b>900mm ELECTRIC RANGE</b>		<b>CONVECTION OVEN - 2/1 GN</b>	
<b>E56D</b> Electrical requirements: 21.0kW, 400-415Vac, 50/60Hz, 3P+N+E			£8,105.00
<b>E56C</b> Electrical requirements: 19.6kW, 400-415Vac, 50/60Hz, 3P+N+E			£8,460.00
<b>E56B</b> Electrical requirements: 18.2kW, 400-415Vac, 50/60Hz, 3P+N+E			£8,795.00
<b>E56A</b> Electrical requirements: 16.8kW, 400-415Vac, 50/60Hz, 3P+N+E			£9,115.00



E56D

900mm	OPTIONAL GRIDDLE PLATE SURFACES	Price (exc. VAT)
<b>PE912R3*</b>	900mm x 12mm Griddle plate – ribbed 300mm RH	£1,865.00
<b>PE912R5*</b>	900mm x 12mm Griddle plate – ribbed 450mm RH	£2,145.00
<b>PE912R9*</b>	900mm x 12mm Griddle plate – ribbed full	£3,105.00

## OPTIONAL EXTRAS ELECTRIC OVEN RANGES

<b>227896</b>	Oven rack to suit E506D series	£95.00
<b>228807</b>	Mobile castor kit ( 2 lockable)	£150.00
<b>013600</b>	Solid cast element	£300.00

Note: The standard plate is not included when ordering an optional griddle plate surface.

\*Options must be specified at the placement of order.

Note: Standard machined finish smooth griddle plate supplied.

Choice of griddle surfaces: Simply order the optional griddle plate model number and unit is supplied with your nominated surface. View options above.

# GAS TILTING BRATT PANS

Model	Dimensions	Gas Power kW	Price (exc. VAT)
-------	------------	--------------	------------------



900mm

## GAS TILTING 80 LITRE BRATT PANS



### G580-8

80 Litre stainless steel pan  
Manually operated tilting mechanism

**Electrical requirements:**

220-240Vac, 50/60Hz, 1P+N+E, 1A  
3 Pin 13A cordset fitted

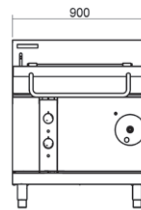

20

£11,545.00

### G580-8E

80 Litre stainless steel pan  
Electric power tilting mechanism

**Electrical requirements:**

220-240Vac, 50/60Hz, 1P+N+E, 1A  
3 Pin 13A cordset fitted

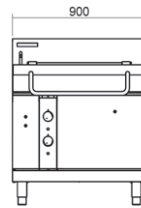

20

£12,425.00

G580-8



1200mm

## GAS TILTING 120 LITRE BRATT PANS



### G580-12

120 Litre stainless steel pan  
Manually operated tilting mechanism

**Electrical requirements:**

220-240Vac, 50/60Hz, 1P+N+E, 1A  
3 Pin 13A cordset fitted

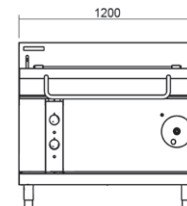

25

£13,775.00

### G580-12E

120 Litre stainless steel pan  
Electric power tilting mechanism G580-12

**Electrical requirements:**

220-240Vac, 50/60Hz, 1P+N+E, 1A  
3 Pin 13A cordset fitted

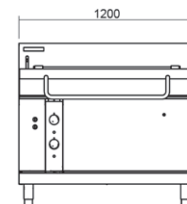

25

£14,615.00

G580-12

## OPTIONAL EXTRAS | BLUE SEAL GAS COOKING EQUIPMENT

**Flex3/4/51**

Flexihose 3/4 (flexible quick coupling hose & tether chain)

£265.00

\*Options must be specified at the placement of order.

# ELECTRIC TILTING BRATT PANS

Model	Dimensions	Price (exc. VAT)
-------	------------	------------------



## 900mm | ELECTRIC TILTING 80 LITRE BRATT PANS

**E580-8**  
80 Litre stainless steel pan  
Manually operated tilting mechanism  
**Electrical requirements:**  
12kW, 400-415Vac, 50/60Hz, 3P+N+E, 17A

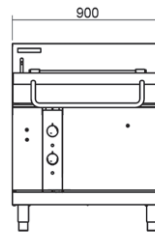

£11,545.00

**E580-8E**  
80 Litre stainless steel pan  
Electric power tilting mechanism E580-8E  
**Electrical requirements:**  
12kW, 400-415Vac, 50/60Hz, 3P+N+E, 17A

£12,425.00

E580-8E



## 1200mm | ELECTRIC TILTING 120 LITRE BRATT PANS

**E580-12**  
120 Litre stainless steel pan  
Manually operated tilting mechanism  
**Electrical requirements:**  
17kW, 400-415Vac, 50/60Hz, 3P+N+E, 23A

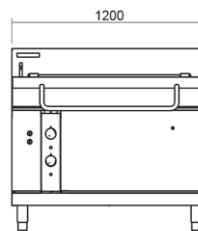

£13,775.00

**E580-12E**  
120 Litre stainless steel pan  
Electric power tilting mechanism  
**Electrical requirements:**  
17kW, 400-415Vac, 50/60Hz, 3P+N+E, 23A

£14,615.00

E580-12E



## EB45D | BAIN-MARIE

W 450mm x D 812mm x H 915mm Incl. heater 1224mm  
Heating Elements 1 x 1kW surface mount element  
Cold water connection 184mm from right hand side, 555mm from floor  
R1/2 (BSP) male  
550kPa 80psi maximum water pressure  
Nett weight 53kg nett

3kW  
13amp

£4,430.00

EB45D

**Electrical requirements:**  
3kW, 13A. Supplied with cordset.

# GAS GRIDDLES



GP513-LS

Model	Dimensions	Gas Power kW	Price (exc. VAT)
<b>GP513</b>	<b>GAS GRIDDLE 450mm</b>		
450mm gas griddle	Dimensions: mm (w x d x h)		
11.5kW thermostatic burner	<b>GP513-B</b>	450 x 812 x 485	11.1
Top weld sealed plates	<b>GP513-LS</b>	450 x 812 x 1085	11.1
Mirror chromed plate option	<b>GP513-CB</b>	450 x 812 x 1085	11.1
20mm thick griddle plate			
Heavy-duty thermostatic griddle			
Full pilot and flame failure with piezo ignition			
2 models of the base unit			
Easy clean, installation and service			

**OPTIONS** - must be specified at placement of order:

<b>PGH420C</b>	450mm x 20mm Heavy-duty griddle plate - chromed	£2,190.00
<b>PGH420R5</b>	450mm x 20mm Heavy-duty griddle plate - ribbed full	£2,950.00

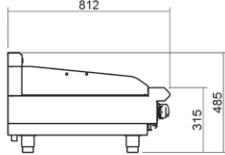

GP514-B

600mm GAS GRIDDLE	<b>BENCH MODEL</b>			
<b>GP514-B</b>			14.5	£4,645.00

**STANDARD PLATE SUPPLIED** Smooth machined finish mild steel plate PGH620

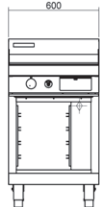
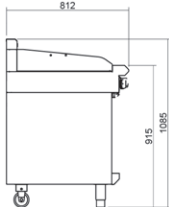

GP514-CB

600mm GAS GRIDDLE	<b>CABINET BASE (RACKING KIT NOT INCLUDED)</b>			
<b>GP514-CB</b>			14.5	£5,245.00

**OPTIONAL** **228791** Gastronorm racking kit 1/1 GN / 4 position £275.00

**STANDARD PLATE SUPPLIED** Smooth machined finish mild steel plate PGH620

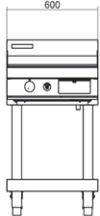
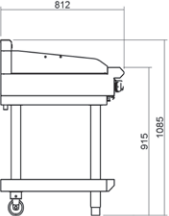

GP514-LS

600mm GAS GRIDDLE	<b>LEG STAND</b>			
<b>GP514-LS</b>			14.5	£5,035.00

**STANDARD PLATE SUPPLIED** Smooth machined finish mild steel plate PGH620

**Choice of griddle surfaces:** Simply order the optional griddle plate model number and unit is supplied with your nominated surface. View options page 42.  
**Note:** The standard plate is not included when ordering an optional griddle plate surface.

# GAS GRIDDLES

## OPTIONAL EXTRAS | 600mm GRIDDLE PLATE SURFACES – CHROMED/RIBBED

<b>PGH620C*</b>	600mm x 20mm Heavy-duty griddle plate – chromed	£2,270.00
<b>PGH620R3*</b>	600mm x 20mm Heavy-duty griddle plate – ribbed 300RH	£3,485.00
<b>PGH620R3C*</b>	600mm x 20mm Heavy-duty griddle plate – ribbed 300RH chromed	£2,670.00
<b>PGH620R6*</b>	600mm x 20mm Heavy-duty griddle plate – ribbed full	£2,585.00
<b>PGH620R6C</b>	600mm x 20mm Heavy-duty griddle plate – ribbed full channel	£2,700.00

\*Options must be specified at the placement of order.

Model	Dimensions	Gas Power kW	Price (exc. VAT)
-------	------------	--------------	------------------



### 900mm GAS GRIDDLE

### BENCH MODEL



**GP516-B**



23

£5,470.00

**GP516-B**

### STANDARD PLATE SUPPLIED

Smooth machined finish mild steel plate PGH920



### 900mm GAS GRIDDLE

### CABINET BASE (RACKING KIT NOT INCLUDED)



**GP516-CB**

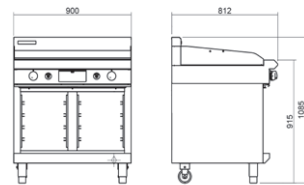

23

£6,330.00

**GP516-CB**

### OPTIONAL

**228791** Gastronorm racking kit 1/1 GN / 4 position / 900mm Cabinet Base Accommodates 1 or 2 Racking Kits

£275.00

### STANDARD PLATE SUPPLIED

Smooth machined finish mild steel plate PGH920



### 900mm GAS GRIDDLE

### LEG STAND



**GP516-LS**

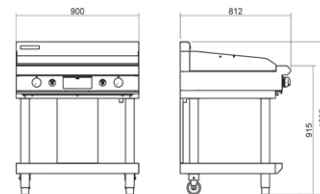

23

£5,895.00

**GP516-LS**

### STANDARD PLATE SUPPLIED

Smooth machined finish mild steel plate PGH920

Choice of griddle surfaces: Simply order the optional griddle plate model number and unit is supplied with your nominated surface. View options page 43.

# GAS GRIDDLES



GP516-RB

Model	Dimensions	Gas Power kW	Price (exc. VAT)
-------	------------	--------------	------------------

## 900mm GAS GRIDDLE

## REFRIGERATED BASE, 2 x 1/1 GN DRAWERS

### GP516-RB

(RB) Electrical requirements:  
0.5kW, 220-240Vac,  
50Hz, 1P+N+E, 1.8A,  
3 pin 13A plug cordset fitted

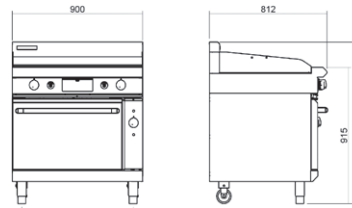

23

£10,930.00

### STANDARD PLATE SUPPLIED

Smooth machined finish mild steel plate PGH920

### OPTIONAL EXTRAS

### 900mm GRIDDLE PLATE SURFACES – CHROMED/RIBBED

PGH920C*	900mm x 20mm Heavy-duty griddle plate – chromed	£3,175.00
PGH920R3*	900mm x 20mm Heavy-duty griddle plate – ribbed 300RH	£3,135.00
PGH920R3C*	900mm x 20mm Heavy-duty griddle plate – ribbed 300RH chromed	£3,250.00
PGH920R5*	900mm x 20mm Heavy-duty griddle plate – ribbed 450RH	£3,300.00
PGH920R9*	900mm x 20mm Heavy-duty griddle plate – ribbed full	£3,270.00
PGH920R5C*	900mm x 20mm Heavy-duty griddle plate – 450RH chromed	£3,345.00

**Note:** The standard plate is not included when ordering an optional griddle plate surface.  
\*Options must be specified at the placement of order.

## 1200mm GAS GRIDDLE

## BENCH MODEL

### GP518-B



31

£7,550.00

GP518-B

### STANDARD PLATE SUPPLIED

Smooth machined finish mild steel plate PGH1220

## 1200mm GAS GRIDDLE

## CABINET BASE (RACKING KIT NOT INCLUDED)

### GP518-CB

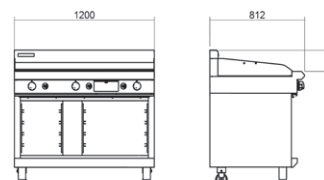

31

£8,400.00

### OPTIONAL

228791

Gastronorm racking kit 1/1 GN / 4 position / 1200mm Cabinet Base Accommodates 1 or 2 Racking Kits

£275.00

GP518-CB

### STANDARD PLATE SUPPLIED

Smooth machined finish mild steel plate PGH1220

**Choice of griddle surfaces:** Simply order the optional griddle plate model number and unit is supplied with your nominated surface. View options page 44.

# GAS GRIDDLES

Model	Dimensions	Gas Power kW	Price (exc. VAT)
-------	------------	--------------	------------------



**GP518-LS**

**1200mm GAS GRIDDLE**

**LEG STAND**



**GP518-LS**

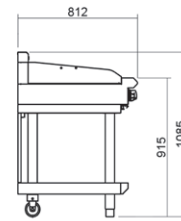
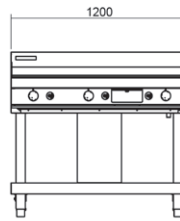

31

£7,790.00

**STANDARD PLATE SUPPLIED**

Smooth machined finish mild steel plate PGH1220

**1200mm GAS GRIDDLE**

**REFRIGERATED BASE, 2 x 1/1 GN DRAWERS / 1 x 1/1 GN DOOR**



**GP518-RB**

**Electrical requirements:**  
220-240Vac,  
50Hz, 1P+N+E, 1.8A,  
3 pin 13A plug cordset fitted

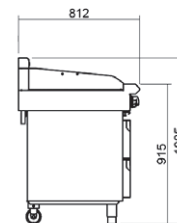
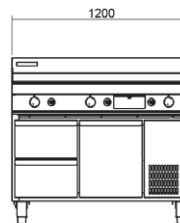

31

£12,600.00

**STANDARD PLATE SUPPLIED**

Smooth machined finish mild steel plate PGH1220

**OPTIONAL EXTRAS**

**1200mm GRIDDLE PLATE SURFACES – CHROMED/RIBBED**

<b>PGH1220C*</b>	1200mm x 20mm Heavy-duty griddle plate – chromed	£4,095.00
<b>PGH1220R4*</b>	1200mm x 20mm Heavy-duty griddle plate – ribbed 400RH	£3,920.00
<b>PGH1220R4C*</b>	1200mm x 20mm Heavy-duty griddle plate – ribbed 400RH chromed	£3,920.00
<b>PGH1220R6*</b>	1200mm x 20mm Heavy-duty griddle plate – ribbed 600RH	£4,645.00
<b>PGH1220R12*</b>	1200mm x 20mm Heavy-duty griddle plate – ribbed full	£3,885.00

**Note:** The standard plate is not included when ordering an optional griddle plate surface.  
\*Options must be specified at the placement of order.

# ELECTRIC GRIDDLES

Model	Dimensions	Price (exc. VAT)
-------	------------	------------------

## 450mm ELECTRIC GRIDDLE

### BENCH MODEL



EP513-B



**EP513-B**

**Electrical requirements:**  
6.0kW, 230-240Vac, 50/60Hz,  
1P+N+E, 25A

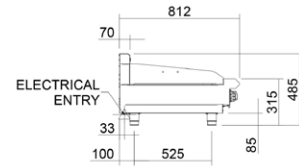

£4,090.00

**STANDARD PLATE SUPPLIED** Smooth machined finish mild steel plate PEH620

## 450mm ELECTRIC GRIDDLE

### CABINET BASE (RACKING KIT NOT INCLUDED)



EP513-CB



**EP513-CB**

**Electrical requirements:**  
6.0kW, 230-240Vac, 50/60Hz,  
1P+N+E, 25A

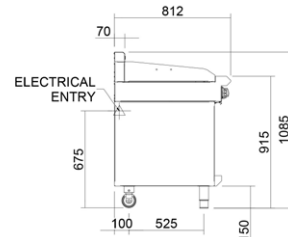
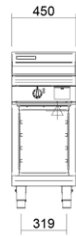

£4,700.00

**OPTIONAL** 228791 Gastronorm racking kit 1/1 GN / 4 position £275.00

**STANDARD PLATE SUPPLIED** Smooth machined finish mild steel plate PEH620

## 450mm ELECTRIC GRIDDLE

### LEG STAND



EP513-LS



**EP513-LS**

**Electrical requirements:**  
6.0kW, 230-240Vac, 50/60Hz,  
1P+N+E, 25A

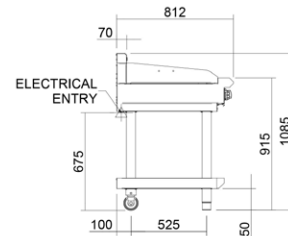

£4,490.00

**STANDARD PLATE SUPPLIED** Smooth machined finish mild steel plate PEH620

### OPTIONAL 450mm GRIDDLE PLATE SURFACES - CHROMED/RIBBED

<b>PEH420C*</b>	450mm x 20mm Heavy-duty griddle plate – chromed	£2,190.00
<b>PEH420R5*</b>	450mm x 20mm Heavy-duty griddle plate – ribbed full	£2,950.00

**Note:** The standard plate is not included when ordering an optional griddle plate surface.  
\*Options must be specified at the placement of order.

**Choice of griddle surfaces:** Simply order the optional griddle plate model number and unit is supplied with your nominated surface. View options above.

## 600mm ELECTRIC GRIDDLE

### BENCH MODEL



EP514-B



**EP514-B**

**Electrical requirements:**  
7.2kW, 230-240Vac, 50/60Hz,  
1P+N+E, 30A

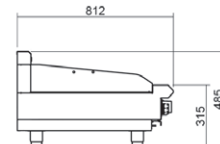
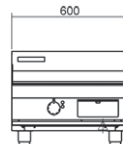

£5,035.00

**STANDARD PLATE SUPPLIED** Smooth machined finish mild steel plate PEH620

# ELECTRIC GRIDDLES

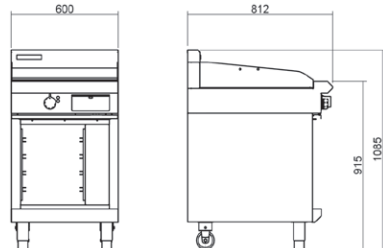
Model	Dimensions	Price (exc. VAT)
600mm ELECTRIC GRIDDLE		<b>CABINET BASE</b> (RACKING KIT NOT INCLUDED) ⚡
<b>EP514-CB</b>		£5,470.00
<b>Electrical requirements:</b> 7.2kW, 230-240Vac, 50/60Hz, 1P+N+E, 30A		
<b>OPTIONAL</b>	<b>228791</b> Gastronorm racking kit 1/1 GN / 4 position	£275.00
<b>STANDARD PLATE SUPPLIED</b> Smooth machined finish mild steel plate PEH620		

EP514-CB

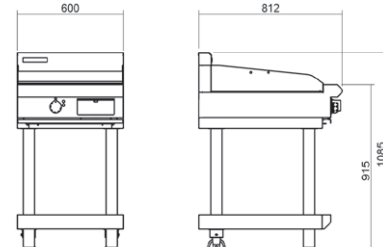

600mm ELECTRIC GRIDDLE		<b>LEG STAND</b> ⚡
<b>EP514-LS</b>		£5,245.00
<b>Electrical requirements:</b> 7.2kW, 230-240Vac, 50/60Hz, 1P+N+E, 30A		
<b>STANDARD PLATE SUPPLIED</b> Smooth machined finish mild steel plate PEH620		

EP514-LS



## OPTIONAL | 600mm GRIDDLE PLATE SURFACES - CHROMED/RIBBED

<b>PEH620C*</b>	600mm x 20mm Heavy-duty griddle plate – chromed	£2,660.00
<b>PEH620R3C*</b>	600mm x 20mm Heavy-duty griddle plate – ribbed 300RH chromed	£2,710.00
<b>PEH620R6*</b>	600mm x 20mm Heavy-duty griddle plate – ribbed full	£2,270.00
<b>PEH620R6C*</b>	600mm x 20mm Heavy-duty griddle plate – ribbed full chromed	£2,425.00

**Note:** The standard plate is not included when ordering an optional griddle plate surface.  
 \*Options must be specified at the placement of order.

**Choice of griddle surfaces:** Simply order the optional griddle plate model number and unit is supplied with your nominated surface. View options above.

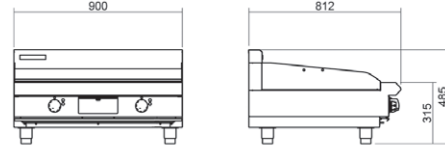
900mm ELECTRIC GRIDDLE		<b>BENCH MODEL</b> ⚡
<b>EP516-B</b>		£5,870.00
<b>Electrical requirements:</b> 12kW, 400-415Vac, 50/60Hz, 3P+N+E, 17A		
<b>STANDARD PLATE SUPPLIED</b> Smooth machined finish mild steel plate PEH920		

EP516-B

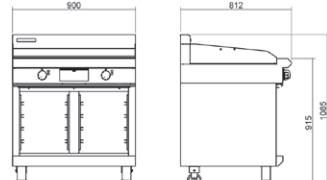

900mm ELECTRIC GRIDDLE		<b>CABINET BASE</b> (RACKING KIT NOT INCLUDED) ⚡
<b>EP516-CB</b>		£6,490.00
<b>Electrical requirements:</b> 12kW, 400-415Vac, 50/60Hz, 3P+N+E, 17A		
<b>OPTIONAL</b>	<b>228791</b> Gastronorm racking kit 1/1 GN / 4 position / 900mm Cabinet Base Accommodates 1 or 2 Racking Kits	£275.00
<b>STANDARD PLATE SUPPLIED</b> Smooth machined finish mild steel plate PEH1220		

EP516-CB



# ELECTRIC GRIDDLES



EP516-LS

Model	Dimensions	Price (exc. VAT)
900mm ELECTRIC GRIDDLE	<b>LEG STAND</b>	
<b>EP516-LS</b>		£6,330.00
<b>Electrical requirements:</b> 12kW, 400-415Vac, 50/60Hz, 3P+N+E, 25A		
<b>STANDARD PLATE SUPPLIED</b>		Smooth machined finish mild steel plate PEH920



EP516-RB

900mm ELECTRIC GRIDDLE	<b>REFRIGERATED BASE, 2 x 1/1 GN DRAWERS</b>	
<b>EP516-RB</b>		£9,460.00
<b>Electrical requirements:</b> 12kW, 400-415Vac, 50/60Hz, 3P+N+E, 25A 3 pin 13A plug, cordset 1.8		
<b>STANDARD PLATE SUPPLIED</b>		Smooth machined finish mild steel plate PEH920

## OPTIONAL 900mm GRIDDLE PLATE SURFACES - CHROMED/RIBBED

<b>PEH920C*</b>	900mm x 20mm Heavy-duty griddle plate – chromed	£2,980.00
<b>PEH920R3*</b>	900mm x 20mm Heavy-duty griddle plate – ribbed 300RH	£3,045.00
<b>PEH920R3C*</b>	900mm x 20mm Heavy-duty griddle plate – ribbed 300RH chromed	£3,215.00
<b>PEH920R5*</b>	900mm x 20mm Heavy-duty griddle plate – ribbed 450RH	£3,105.00
<b>PEH920R9*</b>	900mm x 20mm Heavy-duty griddle plate – ribbed full	£3,145.00

**Note:** The standard plate is not included when ordering an optional griddle plate surface.  
 \*Options must be specified at the placement of order.

**Choice of griddle surfaces:** Simply order the optional griddle plate model number and unit is supplied with your nominated surface. View options above.

1200mm ELECTRIC GRIDDLE	<b>BENCH MODEL</b>	
<b>EP518-B</b>		£7,150.00
<b>Electrical requirements:</b> 16.2kW, 400-415Vac, 50/60Hz, 3P+N+E, 25A		
<b>STANDARD PLATE SUPPLIED</b>		Smooth machined finish mild steel plate PEH1220

1200mm ELECTRIC GRIDDLE	<b>CABINET BASE (RACKING KIT NOT INCLUDED)</b>	
<b>EP518-CB</b>		£7,980.00
<b>Electrical requirements:</b> 16.2kW, 400-415Vac, 50/60Hz, 3P+N+E, 25A		
<b>OPTIONAL</b>	<b>228791</b> Gastronorm racking kit 1/1 GN / 4 position / 1200mm Cabinet Base Accommodates 1 or 2 Racking Kits	£275.00
<b>STANDARD PLATE SUPPLIED</b>		Smooth machined finish mild steel plate PEH1220

# ELECTRIC GRIDDLES



EP518-LS

Model	Dimensions	Price (exc. VAT)
1200mm ELECTRIC GRIDDLE	LEG STAND	

**EP518-LS**

Electrical requirements:  
16.2kW, 400-415Vac, 50/60Hz,  
3P+N+E, 25A

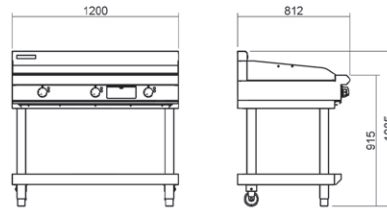

£7,550.00

**STANDARD PLATE SUPPLIED** Smooth machined finish mild steel plate PEH1220

1200mm ELECTRIC GRIDDLE	REFRIGERATED BASE, 2 x 1/1 GN DRAWERS / 1 x 1/1 GN DOOR	

**EP518-RB**

Electrical requirements:  
16.2kW, 400-415Vac, 50/60Hz,  
3P+N+E

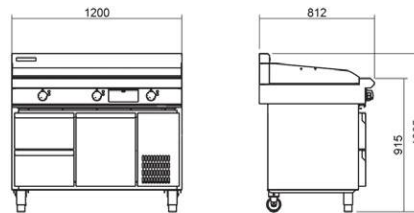

£11,355.00

**STANDARD PLATE SUPPLIED** Smooth machined finish mild steel plate PEH1220

**OPTIONAL | 1200mm GRIDDLE PLATE SURFACES - CHROMED/RIBBED**

<b>PEH1220C*</b>	1200mm x 20mm Heavy-duty griddle plate – chromed	£3,675.00
<b>PEH1220R4C*</b>	1200mm x 20mm Heavy-duty griddle plate – ribbed 400RH chromed	£3,700.00
<b>PEH1220R12*</b>	1200mm x 20mm Heavy-duty griddle plate – ribbed full	£3,195.00

**Note:** The standard plate is not included when ordering an optional griddle plate surface.  
\*Options must be specified at the placement of order.

**Choice of griddle surfaces:** Simply order the optional griddle plate model number and unit is supplied with your nominated surface. View options above.

# GAS GRIDDLE OVENS

Model	Dimensions	Gas Power kW	Price (exc. VAT)
-------	------------	--------------	------------------



**GPE506**

900mm GAS GRIDDLE

**ELECTRIC STATIC OVEN RANGE - 2/1 GN**



**GPE506**

**Electrical requirements:**  
6.5kW, 230-240Vac, 50/60Hz,  
1P+N+E, 27A standard or 6.5kW,  
400-415Vac, 50/60Hz,  
3P+N+E, 10A

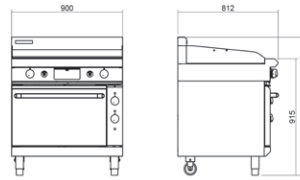

23

£8,375.00

**STANDARD PLATE SUPPLIED**

Smooth machined finish mild steel plate PGH920



**GPE56**

900mm GAS GRIDDLE

**ELECTRIC CONVECTION OVEN RANGE - 2/1 GN**



**GPE56**

**Electrical requirements:**  
6.5kW, 230-240Vac, 50/60Hz,  
1P+N+E, 27.7A standard or 6.6kW,  
400-415Vac, 50/60Hz,  
3P+N+E, 10A

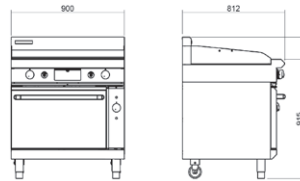

23

£9,190.00

**STANDARD PLATE SUPPLIED**

Smooth machined finish mild steel plate PGH920

## OPTIONAL | 900mm GRIDDLE PLATE SURFACES - CHROMED/RIBBED

<b>PGH920C*</b>	900mm x 20mm Heavy-duty griddle plate – chromed	£3,175.00
<b>PGH920R3*</b>	900mm x 20mm Heavy-duty griddle plate – ribbed 300RH	£3,135.00
<b>PGH920R3C*</b>	900mm x 20mm Heavy-duty griddle plate – ribbed 300RH chromed	£3,250.00
<b>PGH920R5*</b>	900mm x 20mm Heavy-duty griddle plate – ribbed 450RH	£3,300.00
<b>PGH920R9*</b>	900mm x 20mm Heavy-duty griddle plate – ribbed full	£3,270.00
<b>PGH920R5C*</b>	900mm x 20mm Heavy-duty griddle plate – 450RH chromed	£3,345.00

**Note:** The standard plate is not included when ordering an optional griddle plate surface.

\*Options must be specified at the placement of order.

**Choice of griddle surfaces:** Simply order the optional griddle plate model number and unit is supplied with your nominated surface. View options above.

## GAS GRIDDLE OVENS

Model	Dimensions	Gas Power kW	Price (exc. VAT)
-------	------------	--------------	------------------



GPE508

1200mm GAS GRIDDLE

**ELECTRIC STATIC OVEN RANGE – 2/1 GN**



GPE508

**Electrical requirements:**  
6.5kW, 230-240Vac, 50/60Hz,  
1P+N+E, 27A standard or  
6.5kW, 400-415Vac, 50/60Hz,  
3P+N+E, 10A

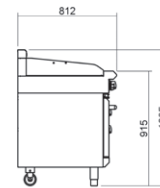
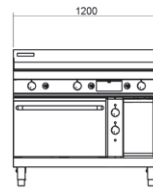

31

£10,075.00

**STANDARD PLATE SUPPLIED** | Smooth machined finish mild steel plate PGH1220



GPE58

1200mm GAS GRIDDLE

**ELECTRIC CONVECTION OVEN RANGE – 2/1 GN**



GPE58

**Electrical requirements:**  
6.6kW, 230-240Vac, 50/60Hz,  
1P+N+E, 27.7A standard or  
6.6kW, 400-415Vac, 50/60Hz,  
3P+N+E, 10A

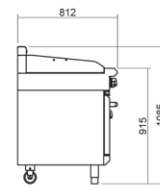
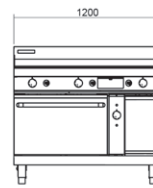

31

£10,930.00

**STANDARD PLATE SUPPLIED** | Smooth machined finish mild steel plate PGH1220

### OPTIONAL | 1200mm GRIDDLE PLATE SURFACES - CHROMED/RIBBED

PGH1220C*	1200mm x 20mm Heavy-duty griddle plate – chromed	£4,095.00
PGH1220R4*	1200mm x 20mm Heavy-duty griddle plate – ribbed 400RH	£3,920.00
PGH1220R4C*	1200mm x 20mm Heavy-duty griddle plate – ribbed 400RH chromed	£3,920.00
PGH1220R6*	1200mm x 20mm Heavy-duty griddle plate – ribbed 600RH	£4,645.00
PGH1220R12*	1200mm x 20mm Heavy-duty griddle plate – ribbed full	£3,885.00

### OPTIONAL EXTRAS | GAS GRIDDLE / GRIDDLE OVENS

228566	Griddle scraper tool C/W blades	£75.00
228567	Smooth plate scraper blades (pack of 10 blades)	£80.00
228568	Ribbed plate scraper blade (individual blade)	£45.00
Flex3/4/51	Flexihose 3/4 (flexible quick coupling hose & tether chain)	£265.00

**Note:** The standard plate is not included when ordering an optional griddle plate surface.

\*Options must be specified at the placement of order.

**Choice of griddle surfaces:** Simply order the optional griddle plate model number and unit is supplied with your nominated surface. View options above.

## GAS GRIDDLE TOASTER

Model	Dimensions	Gas Power kW	Price (exc. VAT)
-------	------------	--------------	------------------



G55T

600mm

**GRIDDLE TOASTER**



G55T

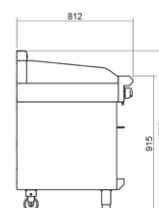

12

£4,410.00

# ELECTRIC GRIDDLE OVENS

Model	Dimensions	Price (exc. VAT)
-------	------------	------------------



EP506

900mm ELECTRIC GRIDDLE

**ELECTRIC STATIC OVEN RANGE  
- 2/1 GN**



**EP506**

Electrical requirements:  
18.5kW, 400-415Vac, 50/60Hz,  
3P+N+E, 26A

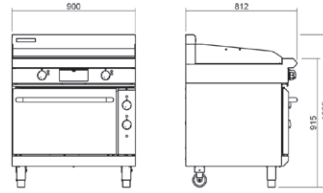

£8,375.00

**STANDARD PLATE SUPPLIED**

Smooth machined finish mild steel plate PEH920



EP56

900mm ELECTRIC GRIDDLE

**ELECTRIC CONVECTION OVEN  
RANGE - 2/1 GN**



**EP56**

Electrical requirements:  
18.6kW, 400-415Vac, 50/60Hz,  
3P+N+E, 27A

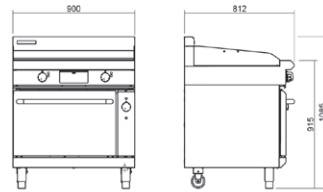

£9,190.00

**STANDARD PLATE SUPPLIED**

Smooth machined finish mild steel plate PEH920

## OPTIONAL

## 900mm GRIDDLE PLATE SURFACES - CHROMED/RIBBED

<b>PEH920C*</b>	900mm x 20mm Heavy-duty griddle plate – chromed	£2,980.00
<b>PEH920R3*</b>	900mm x 20mm Heavy-duty griddle plate – ribbed 300RH	£3,045.00
<b>PEH920R3C*</b>	900mm x 20mm Heavy-duty griddle plate – ribbed 300RH chromed	£3,215.00
<b>PEH920R5*</b>	900mm x 20mm Heavy-duty griddle plate – ribbed 450RH	£3,105.00
<b>PEH920R9*</b>	900mm x 20mm Heavy-duty griddle plate – ribbed full	£3,145.00

## OPTIONAL EXTRAS

## ELECTRIC GRIDDLE / GRIDDLE OVENS











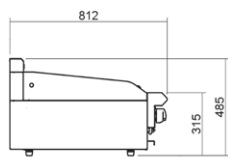

<b>228566</b>	Griddle scraper tool C/W blades	£75.00
<b>228567</b>	Smooth plate scraper blades (pack of 5 blades)	£80.00
<b>228807</b>	Mobile castor kit (set of 2 lockable)	£150.00

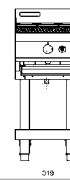
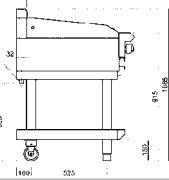
**Note:** The standard plate is not included when ordering an optional griddle plate surface.

\*Options must be specified at the placement of order.

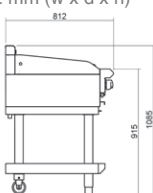
**Choice of griddle surfaces:** Simply order the optional griddle plate model number and unit is supplied with your nominated surface. View options above.

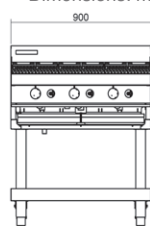
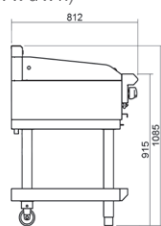
# GAS CHARGRILLS

Model	Chargrill	Dimensions	Gas Power kW	Price (exc. VAT)
		<b>300mm GAS CHARGRILL</b>	<b>BENCH MODEL</b>	
<b>G592-B</b>		 	9.8	£2,480.00
				
<b>G592-B</b>				
		<b>GAS CHARGRILL</b>		
<b>G593 LS</b>		Dimensions: mm (w x d x h)		
<b>G593-LS</b>		 	14.2	£4,490.00
				
<b>G593-LS</b>				
<b>G593-B</b>		450 x 812 x 585	14.2	£4,090.00
		<b>600mm GAS CHARGRILL</b>	<b>LEG STAND</b>	
<b>G594-LS</b>		Dimensions: mm (w x d x h)		
<b>G594-LS</b>		 	18.6	£4,915.00
				
<b>G594-LS</b>				
<b>G594-B</b>		600 x 812 x 585	18.6	£4,490.00
		<b>900mm GAS CHARGRILL</b>	<b>LEG STAND</b>	
<b>G596-LS</b>		Dimensions: mm (w x d x h)		
<b>G596-LS</b>		 	29.3	£5,275.00
				
<b>G596-LS</b>				
<b>G596-B</b>		900 x 812 x 585	29.3	£4,855.00

# GAS CHARGRILLS

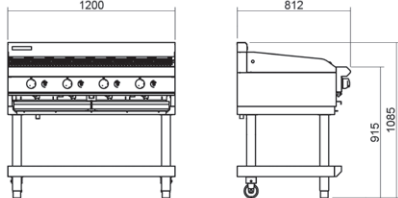

**G598-LS**

Model	Chargrill	Dimensions	Gas Power kW	Price (exc. VAT)
1200mm GAS CHARGRILL		<b>LEG STAND</b>		
<b>G598-LS</b>		Dimensions: mm (w x d x h) 	39.1	<b>£6,130.00</b>
<b>G598-B</b>		1200 x 812 x 585	39.1	<b>£5,720.00</b>



Example with drop on plate fitted.

Model	Description	Price (exc. VAT)
<b>OPTIONAL EXTRAS GAS CHARGRILLS</b>		
<b>228787</b>	Grate Scraper Tool	<b>£240.00</b>
<b>227002</b>	Drop on griddle plate 300mm	<b>£160.00</b>
<b>227003</b>	Drop on griddle plate 450mm	<b>£265.00</b>
<b>228807</b>	Mobile castor kit (set of 4 castors, 2 lockable)	<b>£150.00</b>
<b>Flex3/4/51</b>	Flexi hose 3/4 (flexible quick coupling hose & tether chain)	<b>£265.00</b>
<b>230707</b>	Heavy duty 12mm thick steel griddle plate 300mm	<b>£475.00</b>
<b>230710</b>	Heavy duty 12mm thick steel griddle plate 450mm	<b>£590.00</b>

# ELECTRIC CHARGRILLS - WATER BATH STYLE

Model	Hob Options	Dimensions	Price (exc. VAT)
-------	-------------	------------	------------------



## 600mm ELECTRIC CHARGRILL

## BENCH MODEL



E594D-B

### E594D-B

Electrical requirements:  
8.4kW, 400-415V, 50/60Hz,  
3P+E, 15A

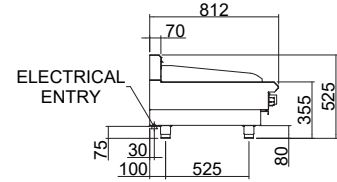

£4,915.00



## 600mm ELECTRIC CHARGRILL

## CABINET BASE (RACKING KIT NOT INCLUDED)



E594D-CB

### E594D-CB

Electrical requirements:  
8.4kW, 400-415V, 50/60Hz,  
3P+E, 15A

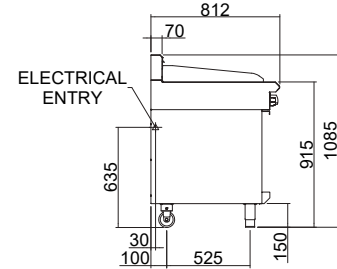
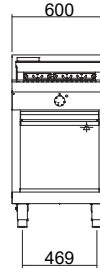

£5,555.00

Model	Description	Price (exc. VAT)
-------	-------------	------------------

### OPTIONAL CABINET BASE GASTRONORM RACKING KIT

237393	Gastronorm racking kit 1/1 GN/4-position: 600mm/900mm/1200mm Cabinet Base	£275.00 (per kit)
--------	---	-------------------

Model	Hob Options	Dimensions	Price (exc. VAT)
-------	-------------	------------	------------------



## 600mm ELECTRIC CHARGRILL

## LEG STAND



E594D-LS

### E594D-LS

Electrical requirements:  
8.4kW, 400-415V, 50/60Hz,  
3P+E, 15A

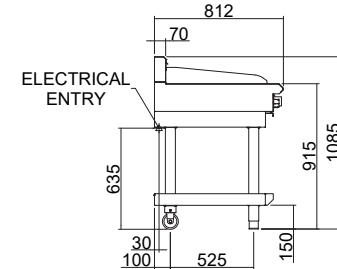
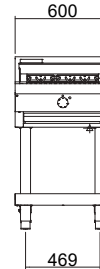

£5,265.00

# ELECTRIC CHARGRILLS - WATER BATH STYLE

Model	Hob Options	Dimensions	Price (exc. VAT)
-------	-------------	------------	------------------

**NEW PRODUCT**



**E596D-B**

900mm ELECTRIC CHARGRILL

**BENCH MODEL**

**E596D-B**

Electrical requirements:  
13.4kW, 400-415V,  
50/60Hz, 3P+N+E, 22.5A

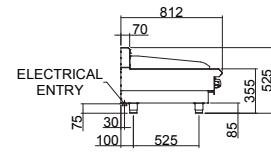
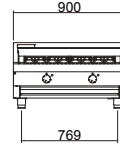

£7,975.00

**NEW PRODUCT**



**E596D-CB**

900mm ELECTRIC CHARGRILL

**CABINET BASE  
(RACKING KIT NOT INCLUDED)**

**E596D-CB**

Electrical requirements:  
13.4kW, 400-415V,  
50/60Hz, 3P+N+E, 22.5A

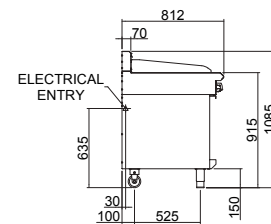

£8,750.00

Model	Description	Price (exc. VAT)
-------	-------------	------------------

## OPTIONAL CABINET BASE GASTRONORM RACKING KIT

**237393**

Gastronorm racking kit 1/1 GN/4 position/600mm/700mm/900mm/1200mm Cabinet Base. Accommodates 1 or 2 Racking Kits

£275.00  
(per kit)

**NEW PRODUCT**



**E596D-LS**

900mm ELECTRIC CHARGRILL

**LEG STAND**

**E596D-LS**

Electrical requirements:  
13.4kW, 400-415V,  
50/60Hz, 3P+N+E, 22.5A

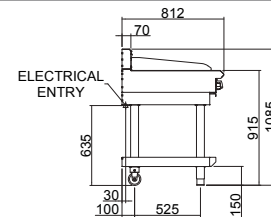

£8,385.00

NB: Drop-on griddle plates are not available for electric chargrills.

# FRYERS, PASTA COOKERS, SALAMANDERS

BLUE SEAL EVOLUTION SERIES®

Blue Seal has long been recognised for the quality and performance of its Fryers. The Evolution Series takes this a stage further with a sleeker, more streamlined Fryer range - available in 450 or 600mm single or twin pan versions. Gas units feature Blue Seal's unique Vee Ray technology, incorporating patented infrared burners for industry leading frying output and recovery.

All Fryers are available with either mechanical or digital controls. Digital control models offer precise temperature control, three product timers, as well as time and temperature digital display. Twin pan models have independent digital controls for each pan and six product timers.

Blue Seal Evolution Series Gas and Electric Salamanders are versatile, easy to use and well equipped with performance features. They can be used for melting, grilling, gratinating and toasting.

Gas models feature energy efficient high-speed infrared burners for fast results. Electric models feature powerful 3kW twin coil elements for optimum cooking performance.

Both gas and electric options will accept a Gastronorm GN 1/1 tray. An optional branding plate is ideal for cooking fish or steak.

The Blue Seal Evolution Series Pasta Cooker is built for speed. Fully modular, and featuring a unique single pan design, it comes well equipped for the continuous production of perfect pasta.

From variable high boil to standby simmer, our patented infrared burner system maintains constant water temperature and enables faster turnaround of product through outstanding recovery times from Low heat settings.

The standard provision of four baskets allows four different pastas to be cooked at the same time.

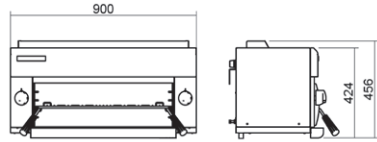

# GAS AND ELECTRIC SALAMANDERS

Model	Dimensions	Gas Power kW	Price (exc. VAT)
900mm	<b>GAS SALAMANDER</b>		
<b>G91B</b>	Four position racking (flat or inclined) includes wall mounting bracket and branding plate	8.8	£2,745.00
			
	<b>OPTIONAL EXTRAS GAS SALAMANDER</b>		
<b>013418B</b>	Branding plate – 620 x 320mm		£265.00
<b>BS91</b>	Floor stand		£1,010.00
<b>B90S-L</b>	Bench stand		£2,095.00

G91B

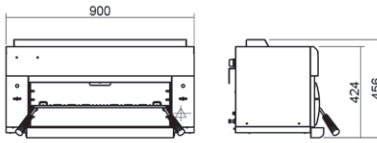

Model	Dimensions	Gas Power kW	Price (exc. VAT)
900mm	<b>ELECTRIC SALAMANDER</b>		
<b>E91B</b>	Four position racking (flat or inclined) Includes wall mounting bracket and branding plate		£2,745.00
			
	Electrical requirements: 6kW, 230-240Vac, 50/60Hz, 1P+N+E, 25A		
	<b>OPTIONAL EXTRAS ELECTRIC SALAMANDER</b>		
<b>013418B</b>	Branding plate – 620 x 320mm		£265.00
<b>BS91</b>	Floor stand		£1,010.00
<b>B90S-L</b>	Bench stand		£2,095.00

E91B



Model	Dimensions	Gas Power kW	Price (exc. VAT)
<b>QSET60</b> <b>QSE60</b>	<b>RAPID HEAT RISE &amp; FALL GRILL</b>		
<b>QSET60</b>	600mm wide x 450mm deep x 500mm high	4	£4,075.00
<b>QSET60</b>	<b>Plate detector as standard.</b>		
<b>QSE60</b>	600mm wide x 450mm deep x 500mm high	4	£3,790.00
<b>9003</b>	Wall brackets		£205.00

QSET60/QSE60



Model	Dimensions	Gas Power kW	Price (exc. VAT)
600mm	<b>SALAMANDER BENCH</b>		
	To suit QSET60/QSE60 rise and fall salamanders.		
<b>B60S-L</b>	Leg stand		£2,095.00
<b>B60S-CB</b>	Cabinet base		£2,230.00



# GAS FRYERS

Model	Dimensions	Gas Power kW	Price (exc. VAT)
-------	------------	--------------	------------------



GT18

400mm

## SINGLE PAN GAS FRYER 400mm



### GT18

400mm wide single pan fryer  
Stainless steel exterior  
18 litre oil capacity  
V- tank with cool zone  
Manual pilot ignition  
30mm drain valve  
90MJ multi- jet target burner  
Fully modular

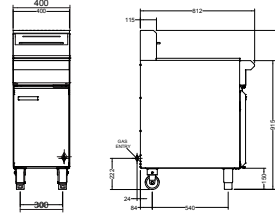

25

£3,035.00



GT45

450mm

## VEE RAY SINGLE PAN GAS FRYERS



### GT45

Single pan  
20 Litre capacity  
Mechanical controls  
Supplied with two standard baskets

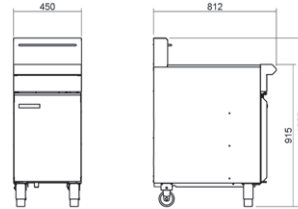

25

£4,615.00

### GT45E

Single pan  
20 Litre capacity  
Digital display electronic controls  
Supplied with two standard baskets

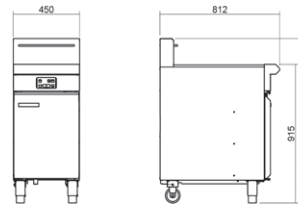

25

£5,245.00

### Electrical requirements:

230-240Vac, 50/60Hz, 1P+N+E, 0.5A  
3 Pin 13A cordset fitted



GT46E

450mm

## VEE RAY TWIN PAN GAS FRYERS



### GT46

Twin pan  
13 Litre capacity each pan  
Mechanical controls  
Supplied with two standard baskets

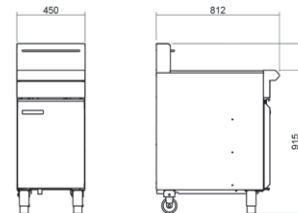

25

£4,755.00

### GT46E

Twin pan  
13 Litre capacity each pan  
Digital display electronic controls  
Supplied with two standard baskets

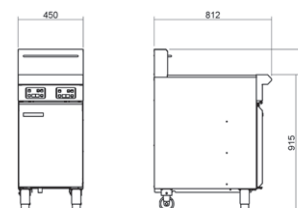

25

£6,260.00

### Electrical requirements:

230-240Vac, 50/60Hz, 1P+N+E, 0.5A  
3 Pin 13A cordset fitted

# GAS FRYERS

Model	Dimensions	Gas Power kW	Price (exc. VAT)
-------	------------	--------------	------------------



GT60E

600mm

## VEE RAY SINGLE PAN GAS FRYERS



### GT60

Single pan  
31 Litre capacity  
Mechanical controls  
Supplied with two large baskets

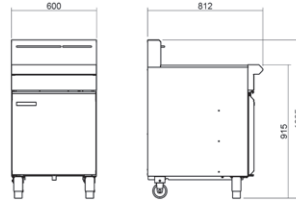

25

£6,375.00

### GT60E

Single pan  
31 Litre capacity  
Digital display electronic controls  
Supplied with two large baskets

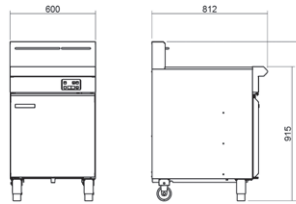

25

£7,220.00

#### Electrical requirements:

230-240Vac, 50/60Hz, 1P+N+E, 0.5A  
3 Pin 13A cordset fitted



CS45E

CS45E

## EVOLUTION CS45 CHIP SCUTTLE WITH ELECTRIC CERAMIC HEATER



CS45E

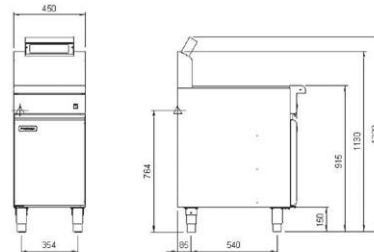

3kW  
13amp

£2,345.00

## OPTIONAL EXTRAS GAS FRYERS

18019



23220



018019	Fryer baskets standard to suit GT45, GT46	£110.00
023220	Fryer baskets large to suit GT60	£180.00
228127	Fish plate GT45	£85.00
228565	Fish plate GT46	£85.00
228128	Fish plate GT60	£90.00
228761	Fryer lift off lid GT45	£85.00
228762	Fryer lift off lid GT60	£85.00
228898	Fryer splashguards LH (450mm wide gas fryers)	£115.00
228899	Fryer splashguards RH (450mm wide gas fryers)	£115.00
018176	Fryer drain stick	£65.00
024705	Fryer drain adaptor kit (allows use of 24710 drain extension) (all fryers)	£160.00
024710	Fryer drain extension kit (to use GT45, GT46)	£225.00
228807	Mobile castor kit (set of 2 lockable)	£150.00
Flex3/4/51	Flexihose 3/4 (flexible quick coupling hose & tether chain)	£265.00
237307	Splashguard LH 400FG-XL - general splashguard to fit side of fryer GT18	£115.00
237308	Splashguard RH 400FG-XR - general splashguard to fit side of fryer GT18	£115.00

Note: Options must be specified at the placement of order.

# ELECTRIC FRYERS

Model	Dimensions	Price (exc. VAT)
-------	------------	------------------



E43

## 450mm SINGLE PAN ELECTRIC FRYERS

**E43**  
Single pan  
27 Litre capacity  
Mechanical controls  
Supplied with two baskets

**Electrical requirements:**  
17kW, 400-415Vac, 50/60Hz,  
3P+N+E, 24A

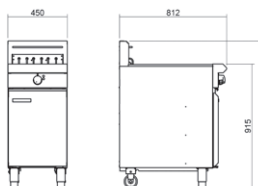

£4,615.00

**E43E**  
Single pan  
27 Litre capacity  
Digital display electronic controls  
Supplied with two baskets

**Electrical requirements:**  
17kW, 400-415Vac, 50/60Hz,  
3P+N+E, 24A

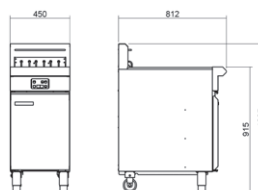

£5,710.00



E44E

## 450mm TWIN PAN ELECTRIC FRYERS

**E44**  
Twin pan  
12 Litre capacity each pan  
Mechanical controls  
Supplied with two baskets

**Electrical requirements:**  
17kW, 400-415Vac, 50/60Hz,  
3P+N+E, 24A

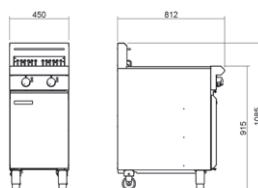

£4,755.00

**E44E**  
Twin pan  
12 Litre capacity each pan  
Digital display electronic controls  
Supplied with two baskets

**Electrical requirements:**  
17kW, 400-415Vac, 50/60Hz,  
3P+N+E, 24A

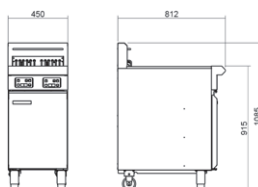

£5,825.00



018019

## OPTIONAL EXTRAS | ELECTRIC FRYERS

018019	Fryer baskets standard to suit E43, E44	£110.00
228898	Fryer splashguards LH (all 450mm electric fryers)	£115.00
228899	Fryer splashguards RH (all 450mm electric fryers)	£115.00
228761	Fryer lift off lid E43, E44 series	£85.00
018176	Fryer drain stick	£65.00
228807	Mobile castor kit (set of 2 lockable)	£150.00

**Note:** Options must be specified at the placement of order.

# ELECTRIC FRYERS

Model	Dimensions	Price (exc. VAT)
-------	------------	------------------



E60

600mm

## SINGLE PAN ELECTRIC FRYERS

### E60

Single pan  
35 Litre capacity  
Mechanical controls  
Supplied with 3 standard baskets

**Electrical requirements:**  
22kW, 400-415Vac, 50/60Hz,  
3P+N+E, 30.5A

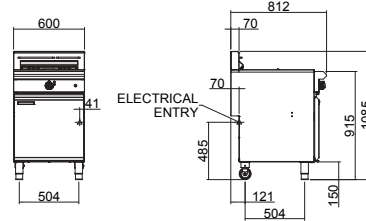

£4,295.00

### E60E

Single pan  
35 Litre capacity  
Digital display electronic controls  
Supplied with 3 standard baskets

**Electrical requirements:**  
22kW, 400-415Vac, 50/60Hz,  
3P+N+E, 30.5A

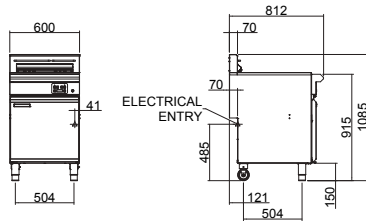

£4,960.00



E66E

600mm

## TWIN PAN ELECTRIC FRYERS

### E66

Twin pan  
17.5 Litre capacity  
Mechanical controls  
Supplied with 2 large baskets

**Electrical requirements:**  
22kW, 400-415Vac, 50/60Hz,  
3P+N+E, 30.5A

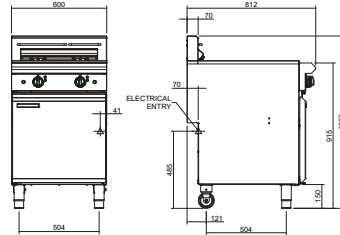

£5,125.00

### E66E

Twin pan  
17.5 Litre capacity  
Digital display electronic controls  
Supplied with 2 large baskets

**Electrical requirements:**  
22kW, 400-415Vac, 50/60Hz,  
3P+N+E, 30.5A

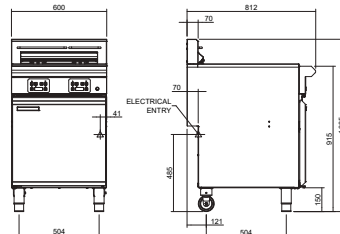

£6,380.00



018019

## OPTIONAL EXTRAS | ELECTRIC FRYERS

018019	Fryer baskets standard to suit 450mm fryer models	£110.00
228900	Fryer splashguards LH (600mm electric fryers)	£115.00
228901	Fryer splashguards RH (600mm electric fryers)	£115.00
228761	Fryer lift off lid to suit 450mm fryer models	£85.00
018176	Fryer drain stick	£65.00
024705	Fryer drain adaptor kit (allows use of 024710 drain extension) (all fryers)	£160.00
024710	Fryer drain extension kit to suit 450mm fryer models	£225.00
228807	Mobile castor kit (set of 2 lockable castors)	£150.00
23220	Fryer basket standard to suit 600mm fryer models	£180.00
228762	Fryer lift off lid to suit 600mm fryer models	£85.00
FLEX 3/4/51	Flexhose 3/4 (flexible quick coupling hose and tether chain)	£265.00

Note: Options must be specified at the placement of order.

# FRYER FILTERS



Model	Dimensions	Price (exc. VAT)
-------	------------	------------------

## FILTAMAX | FRYER FILTERS

**EF30 20 Litre**  
 Reusable Filter Bag.  
 Filtamax Filter fits under the following: GT45, GT45E, GT46, GT46E

**Electrical requirements:**  
 0.77kW, 220-240Vac, 50Hz, 1P+N+E, 6.4A, 3 PIN, 10A Cordset fitted

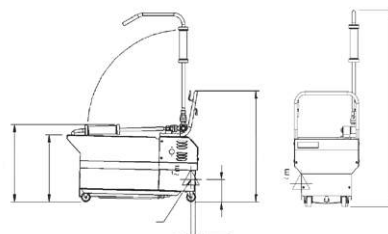

£3,505.00

**EF35 30 Litre**  
 Reusable Filter Bag.  
 Filtamax Filter cannot be stored under fryers.  
 E35 for use with E43, E43E, E44, E44E

**Electrical requirements:**  
 0.77kW, 220-240Vac, 50Hz, 1P+N+E, 6.4A, 3 PIN, Cordset fitted

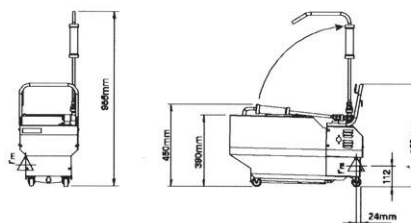

£3,700.00

**EF40 32 Litre**  
 Reusable Filter Bag.  
 Filtamax Filter fits under fryer model, GT60, GT60E

**Electrical requirements:**  
 0.77kW, 220-240Vac, 50Hz, 1P+N+E, 6.4A, 3 PIN, Cordset fitted

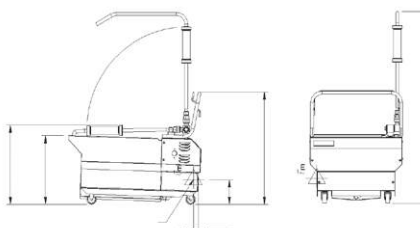

£4,365.00

## OPTIONAL EXTRAS | FILTAMAX FRYER FILTERS

<b>025669</b>	Filter Pad Kit for Filtamax	£555.00
<b>022815</b>	Pad Consumables Pack of 30	£250.00
<b>020417</b>	Flexible Filter Return Hose Arm	£940.00
<b>SA1159</b>	Filter extension arm fixed EF30, EF35 (for electric fryers)	£605.00

# SINGLE PAN PASTA COOKERS



- High performance single pan pasta cooker
- Patented infra-red burner system
- Easy clean 316 grade stainless steel open pan
- 40 Litre water capacity
- Integrated water fill and starch skimming water faucet
- Six stainless steel pasta baskets supplied standard
- Incorporated basket drain stand
- Safety cut out thermostat for empty pan/water boil out
- Stainless steel exterior
- Easy service
- Fully modular

Model	Dimensions	Gas Power kW	Price (exc. VAT)
-------	------------	--------------	------------------

450mm

## GAS PASTA COOKER



G47



**G47**  
Single Tank  
Pasta Cooker

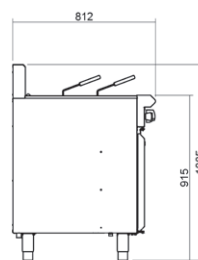
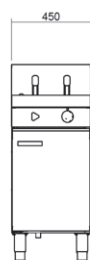

13.5

£5,225.00

Unit comes with six portion baskets as standard.

450mm

## ELECTRIC PASTA COOKERS



E47



**E47-7**  
Single phase

**E47**  
3 phase

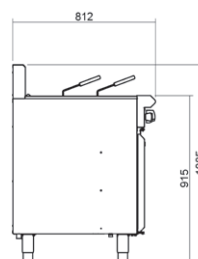
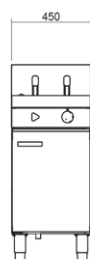

7.0

£5,225.00

10.5

£5,225.00

Unit comes with six portion baskets as standard.

## OPTIONAL EXTRAS | PASTA COOKER BASKETS



229836

229837

**229836**

Pasta Basket W 165mm x D 165mm x H 180mm

£185.00

**229837**

Pasta Basket W 320mm x D 165mm x H 180mm

£245.00

**Note:** Pasta Cooker Basket Combinations:

- Six Square (standard supply)
- Two square / one rectangular
- Two large rectangular

**240516**

Gas Pasta Cooker Noodle Frame and Basket Kit

£370.00

**240542**

Electric Pasta Cooker Noodle Frame and Basket Kit

£370.00

**238674**

L Hand W 165mm x 125mm







£160.00

**238819**

R Hand W 165mm x 125mm

£160.00

## IN-FILL TABLES

	Model	Dimensions	Price (exc. VAT)
	<b>300mm</b>	<b>PROFILED IN-FILL TABLE</b>	
<b>BS TABLE B30-C</b>	Stainless steel Profiled In - Fill Table complete with stub back suitable for all Blue Seal Evolution Series products.	915mm h x 812mm d x 300mm w	<b>£1,185.00</b>
	<b>300mm</b>	<b>PROFILED IN-FILL TABLE</b>	
<b>BS TABLE B30-L</b>	Stainless steel Profiled In - Fill Table complete with stub back suitable for all Blue Seal Evolution Series products.	915mm h x 812mm d x 300mm w	<b>£1,075.00</b>
	<b>450mm</b>	<b>PROFILED IN-FILL TABLE</b>	
<b>BS TABLE B45-L</b>	Stainless steel Profiled In - Fill Table complete with stub back suitable for all Blue Seal Evolution Series products.	915mm h x 812mm d x 450mm w	<b>£1,340.00</b>
	<b>600mm</b>	<b>PROFILED IN-FILL TABLE</b>	
<b>BS TABLE B60-L</b>	Stainless steel Profiled In - Fill Table complete with stub back suitable for all Blue Seal Evolution Series products.	915mm h x 812mm d x 600mm w	<b>£1,480.00</b>
	<b>900mm</b>	<b>PROFILED IN-FILL TABLE</b>	
<b>BS TABLE B90-L</b>	Stainless steel Profiled In - Fill Table complete with stub back suitable for all Blue Seal Evolution Series products.	915mm h x 812mm d x 900mm w	<b>£1,710.00</b>
	<b>900mm</b>	<b>PROFILED IN-FILL TABLE/REFRIGERATED BASE</b>	
<b>BS TABLE B90-RB</b>	Stainless steel Profiled In - Fill Table complete with stub back suitable for all Blue Seal Evolution Series products.	915mm h x 812mm d x 900mm w Refrigerated base. 2 draw GN-sized.	<b>£3,990.00</b>
	<b>900mm</b>	<b>PROFILED IN-FILL TABLE/SALAMANDER GRILL BRACKET</b>	
<b>BS TABLE B90S-L</b>	Stainless steel Profiled In - Fill Table complete with stub back suitable for all Blue Seal Evolution Series products.	915mm h x 812mm d x 900mm w Fitted with Salamander grill bracket.	<b>£2,095.00</b>



Model	Dimensions	Price (exc. VAT)
600mm	<b>SALAMANDER BENCH</b>	

To suit QSET60/QSE60 rise and fall salamanders.

<b>B60S-L</b> Leg stand	£2,095.00
<b>B60S-CB</b> Cabinet base	£2,230.00

## OPTIONAL EXTRAS FOR BLUE SEAL GAS AND ELECTRIC EQUIPMENT

Product	Model	Description	Price (exc. VAT)
---------	-------	-------------	------------------

### OPTIONAL EXTRAS | BLUE SEAL GAS AND ELECTRIC EQUIPMENT

COOKTOP / RANGES	<b>230013</b>	Bench shield, fits LH or RH of open burners	£135.00
	<b>227855</b>	Bench feet	£40.00
CABINET BASES	<b>228791</b>	Gastronorm racking kit / cabinets standard w/o racking / 900mm / 1200mm cabinet bases £240 accommodates 1 or 2 racking kits fits 1/1 GN or 2/1 GN6	£275.00
RANGE OVENS	<b>228106</b>	Oven rack to suit G504, G505, G524	£90.00
	<b>227896</b>	Oven rack to suit G506, G508	£95.00
TARGET TOPS	<b>014997</b>	Casting hook	£80.00
	<b>227855</b>	Bench feet	£40.00
GRIDDLES / GRIDDLE OVENS	<b>228566</b>	Griddle scraper tool c/w blades	£75.00
	<b>228567</b>	Smooth plate scraper blades (Pack of 10)	£80.00
	<b>228568</b>	Ribbed plate scraper blade (individual blade)	£45.00
	<b>227855</b>	Bench feet	£40.00
CHARGRILLS	<b>228787</b>	Grate scraper tool	£240.00
	<b>227002</b>	Chargrill griddle plate 300mm	£160.00
	<b>227003</b>	Chargrill griddle plate 450mm	£265.00
	<b>227855</b>	Bench feet	£40.00
SALAMANDERS	<b>013418</b>	Salamander branding kit / one double-sided ribbed aluminium branding plate / fits both rack system models	£265.00
FRYERS	<b>018019</b>	Fryer baskets standard to suit GT45, GT46 gas series, E43, E44	£110.00
	<b>023220</b>	Fryer baskets large to suit GT60, GT60-HPO	£180.00
	<b>228898</b>	Fryer splashguards LH	£115.00
	<b>228899</b>	Fryer splashguards RH	£115.00
	<b>228127</b>	Fish plate GT45	£85.00
	<b>228565</b>	Fish plate GT46	£85.00
	<b>228128</b>	Fish plate GT60, GT60-HPO--	£90.00
	<b>228761</b>	Fryer lift off lid GT45, E43, E44	£85.00
	<b>228762</b>	Fryer lift off lid GT60, GT60-HPO	£85.00
	<b>018176</b>	Fryer drain stick	£65.00
	<b>024705</b>	Fryer drain adaptor kit (allows use of 24710 drain extension) (all fryers)	£160.00
	<b>024710</b>	Fryer drain extension kit to use GT45, GT46, E43, E44 series with 40 litre filtamax machine	£225.00
	FRYER FILTER	<b>022815</b>	Filter pad kit for Filtamax (upgrades Filtamax to carbon pad system)
<b>020417</b>		Filter flexible hose return arm	£940.00
<b>SA1559</b>		Filter extension arm fixed EF30, EF35	£605.00
<b>SA1556</b>		Filter extension arm fixed EF40	£605.00

### JOINING CAPS | NOT AVAILABLE

- Cooktops Open – Griddle Toaster
- Cooktops Open – Cooktop Electric
- Cooktops Open – Cooktop Electric Griddle
- Cooktop Griddle – Cooktop Electric
- Target Top – Griddle Toaster
- Fryer Gas – Fryer Electric
- Fryer Gas – Bratt Pan
- Fryer Electric – Fryer Gas
- Fryer Electric – Bratt Pan
- Bratt Pan – Fryer Gas
- Bratt Pan – Fryer Electric
- Bratt Pan – Griddle Toaster
- Griddle Toaster – Cooktop Open
- Griddle Toaster – Target Top
- Griddle Toaster – Bratt Pan
- Griddle Toaster – Cooktop Electric
- Cooktop Electric – Cooktop Open
- Cooktop Electric – Cooktop Griddle
- Cooktop Electric – Griddle Toaster
- Cooktop Electric – Cooktop Open

Note: Options must be specified at the placement of order.

# JOINING CAPS FOR BLUE SEAL GAS AND ELECTRIC EQUIPMENT

Part No.	Type	Application / By Products	Notes	Price (exc. VAT)
<b>JOINING CAPS FOR BLUE SEAL GAS AND ELECTRIC EQUIPMENT</b>				
228579	C-C	Cooktops Open – Cooktops Open Cooktops Open – Chargrill Cooktops Open – Cooktop Griddle	Kit – Capping piece + 2 x levelling tabs Required if joined with griddle section	£65.00
228587	GP-CO	Griddles – Cooktops Open		£65.00
228595	TT-C	Target Top – Cooktops Open Target Tops - Chargrill Target Tops - Cooktop Griddles		£65.00
228889	TT-TT	Target Tops - Target Tops		£115.00
228890	TT-GP	Target Tops - Griddle		£115.00
228589	BP-BP	Bratt Pan – Bratt Pan		£65.00
228604	BP-C	Bratt Pan – Cooktop Open Bratt Pan - Chargrill Bratt Pan – Cooktops Electric Bratt Pan – Cooktop Griddle		£70.00
228891	BP-TT	Bratt Pan – Target Top		£115.00
228892	BP-GP	Bratt Pan – Griddle		£115.00
228893	G-G	Chargrill – Chargrill Chargrill – Cooktop Griddle Chargrill – Griddle Chargrill – Griddle Toaster Griddle Toaster – Griddle Toaster Griddle – Griddle Cooktop Griddle – Cooktop Griddle Electric Cooktop Griddle - Electric Cooktop Griddle	Type G-G Caps griddle raised sides of grills	£65.00
228894*	FG-GL	Fryer Gas – Cooktop Griddle Fryer Gas – Chargrill Caps over grill sides Fryer Gas – Griddle Fryer Gas – Griddle Toaster	FITS LH SIDE OF FRYER	£85.00
228895*	FG-GR	Fryer Gas – Cooktop Griddle Fryer Gas – Chargrill Caps over grill sides Fryer Gas – Griddle Fryer Gas – Griddle Toaster	FITS RH SIDE OF FRYER	£85.00
228896*	FE-GL	Fryer Electric – Cooktop Griddle Fryer Electric – Chargrill Fryer Electric – Griddle Fryer Electric – Griddle Toaster	FITS LH SIDE OF FRYER Caps over grill sides	£135.00
228897*	FE-GR	Fryer Electric – Cooktop Griddle Fryer Electric – Chargrill Fryer Electric – Griddle Fryer Electric – Griddle Toaster	FITS RH SIDE OF FRYER Caps over grill sides	£95.00
228600	FG-FG	Fryer Gas – Fryer Gas	Caps across 2 Tanks	£65.00
228601	FE-FE	Fryer Electric – Fryer Electric	Caps across 2 Tanks	£115.00
247924	FE-FE	E44-E44 only	Caps across 2 Tanks	£150.00

NOTE: PRODUCT GROUPS NOTED IN APPLICATION BY PRODUCT (PAIRS) CAN BE LOCATED WITH THE EXCEPTION OF JOINING CAPS MARKED \* ARE DEDICATED LEFT OR RIGHT HAND SIDE FIT.

# COBRA®

YOUR STYLE, YOUR WAY



Powerful, the Cobra Series is the solution for those who demand reliability and capability. Cobra is suited to a large range of eateries – anywhere that needs solid raw power, specific cooking equipment that offers cuisine flexibility when cooking a diverse menu.

# COBRA® - MEDIUM DUTY MODULAR COOKING EQUIPMENT

Model	Hob Options	Dimensions	Gas kW / BTU	Price (exc. VAT)
-------	-------------	------------	--------------	------------------

## GAS COOKTOPS



C6D-B

### 600mm GAS COOKTOPS

### 4 BURNER BENCH MODEL

**C6D-B**

4 Open burners, bench model



20 £2,155.00

75,790

**C6C-B**

2 Open burners, LH side, 300mm Griddle plate, RH side, bench model



15 £2,470.00

56,840

**C6B-B**

600mm Griddle plate, bench model



10 £2,790.00

37,890

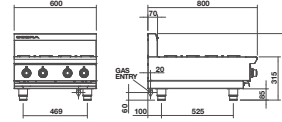

**Note:** Flame failure standard on open burners.



C6D

### 600mm GAS COOKTOPS

### 4 BURNER OPEN CABINET BASE

**C6D**

4 Open burners, open cabinet base under



20 £2,175.00

75,790

**C6C**

2 Open burners, LH side, 300mm Griddle plate, RH side, open cabinet base under



15 £2,815.00

56,840

**C6B**

600mm Griddle plate, open cabinet base under



10 £3,135.00

37,890

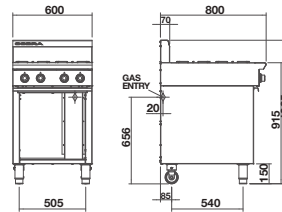

**Note:** Flame failure standard on open burners.



C9D-B

### 900mm GAS COOKTOPS

### 6 BURNER BENCH MODEL

**C9D-B**

6 Open burners, bench model



30 £2,495.00

113,680

**C9C-B**

4 Open burners, LH side, 300mm Griddle plate, RH side, bench model



25 £2,815.00

94,730

**C9B-B**

2 Open burners, LH side, 600mm Griddle plate, bench model



20 £3,135.00

75,790

**C9A-B**

900mm Griddle plate, bench model



15 £3,450.00

56,840

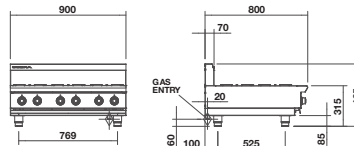

**Note:** Flame failure standard on open burners.

Model	Hob Options	Dimensions	Gas kW / BTU	Price (exc. VAT)
-------	-------------	------------	--------------	------------------

GAS COOKTOPS

900mm GAS COOKTOPS

6 BURNER OPEN CABINET BASE



C9B

**C9D**  
6 Open burners,  
open cabinet base under



30  
£2,720.00  
113,680

**C9C**  
4 Open burners, LH side,  
300mm griddle plate,  
RH side, open cabinet  
base under



25  
£3,065.00  
94,730

**C9B**  
2 Open burners, LH side,  
600mm griddle plate,  
RH side, open cabinet  
base under



20  
£3,395.00  
75,790

**C9A**  
900mm Griddle plate,  
open cabinet base under



15  
£3,740.00  
56,840

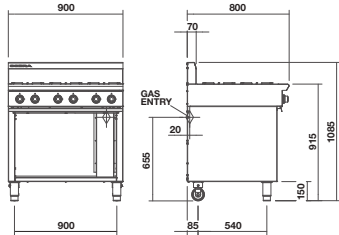

Note: Flame failure standard on open burners.

GAS RANGES

600mm GAS RANGES

GAS STATIC OVEN RANGE



CR6D

**CR6D**  
4 Open burners,  
static oven under



26.5  
£2,835.00  
100,415

**CR6C**  
2 Open burners,  
300mm griddle plate,  
static oven under



88  
£3,160.00  
81,470

**CR6B**  
600mm Griddle plate,  
static oven under



64  
£3,485.00  
65,525

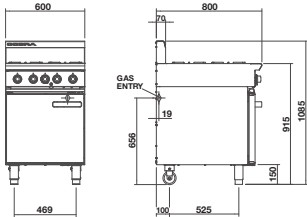

Note: Flame failure standard on open burners.

# COBRA<sup>®</sup> - MEDIUM DUTY MODULAR COOKING EQUIPMENT

Model	Hob Options	Dimensions	Gas kW / BTU	Price (exc. VAT)
-------	-------------	------------	--------------	------------------

## GAS RANGES



CR9C

### 900mm GAS RANGES

#### CR9D

6 Open burners, 2/1 GN, static oven under



#### CR9C

4 Open burners 300mm griddle plate, 2/1 GN, static oven under



#### CR9B

2 Open burners 600mm griddle plate, 2/1 GN, static oven under



#### CR9A

900mm Griddle plate, 2/1 GN, static oven under



### GAS STATIC OVEN RANGE - 2/1 GN

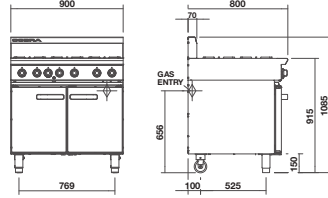

37.5      £3,115.00

142,100

32.5      £3,765.00

123,150

27.5      £4,080.00

104,200

22.5      £4,405.00

85,260

Note: Flame failure standard on open burners.

## OPTIONAL EXTRAS – GAS RANGES

233954	Oven rack to suit 600mm oven range	£65.00
230556	Oven rack to suit 900mm oven range	£75.00
UKCSP4	Plate shelf and splashback to suit 600mm oven range	£725.00
UKCSP6	Splashback, overshelf and grill shelf to suit 900mm oven range	£725.00

## GAS BARBECUES



CB6-B

### 600mm GAS BARBECUE

#### CB6-B

600mm BBQ, bench model



### BENCH MODEL

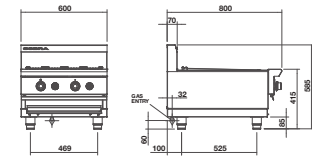

18      £2,495.00

68,200

### 600mm GAS BARBECUE

#### CB6

600mm BBQ, mounted on open cabinet base



### OPEN CABINET BASE

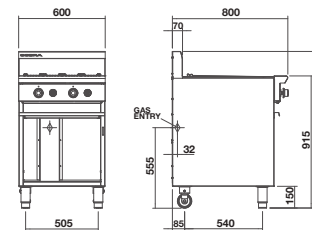

18      £2,720.00

68,200



CB6

# GAS RANGES, BARBECUES, SALAMANDER & GRIDDLE TOASTERS

Model	Hob Options	Dimensions	Gas kW / BTU	Price (exc. VAT)
-------	-------------	------------	--------------	------------------

## GAS BARBECUES



900mm GAS BARBECUE

BENCH MODEL

**CB9-B**  
900mm BBQ, bench model

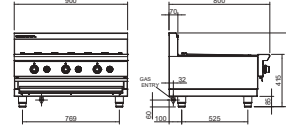

27

£3,045.00

102,310

CB9-B



900mm GAS BARBECUE

OPEN CABINET BASE

**CB9**  
900mm BBQ, mounted on open cabinet base

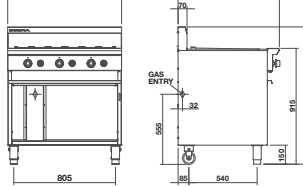

27

£3,330.00

102,310

CB9

## GAS SALAMANDER



900mm

GAS SALAMANDER

**CS9**  
Four position racking (flat or inclined)

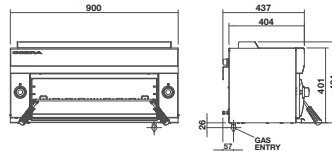

8.8

£2,190.00

33,350

CS9

### OPTIONAL EXTRAS – SALAMANDER

013418B

Branding plate - 620 x 320mm

£265.00

## GAS GRIDDLE TOASTERS



600mm

GAS GRIDDLE TOASTER

**CT6**  
600mm Griddle, toaster compartment

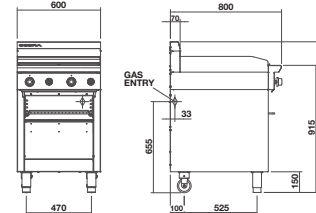

11

£2,950.00

41,700

CT6

# COBRA® - MEDIUM DUTY MODULAR COOKING EQUIPMENT

Model	Hob Options	Dimensions	Gas kW / BTU	Price (exc. VAT)
-------	-------------	------------	--------------	------------------

## GAS FRYER



CF2

SINGLE PAN

18 Litre oil capacity,  
mechanical thermostat  
25kg / hr production rate  
supplied with baskets & lid

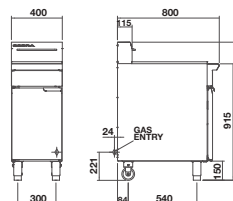

25

£2,285.00

85,250

CF2

### OPTIONAL EXTRAS – GAS fryer

237427	Fish plate	£65.00
237306	Joining cap	£65.00
237307	Splashguard LH 400FG-XL – general splashguard to fit side of fryer	£115.00
237308	Splashguard RH 400FG-XR – general splashguard to fit side of fryer	£115.00
237310	Splashguard LH 400FG-GL – splashguard to join fryer to cooktop griddles / barbecue / griddle toaster	£115.00
237311	Splashguard RH 400FG-GR – splashguard to join fryer to cooktop griddles / barbecue / griddle toaster	£115.00

# GAS GRIDDLE TOASTERS, FRYER & COOKERS

Model	Hob Options	Dimensions	Gas kW / BTU	Price (exc. VAT)
-------	-------------	------------	--------------	------------------

## GAS PASTA COOKER



CP4

450mm PASTA COOKER

SINGLE PAN

**CP4**  
40 Litre water capacity, mechanical thermostat patented infra-red burner system, 6 stainless steel pasta baskets included

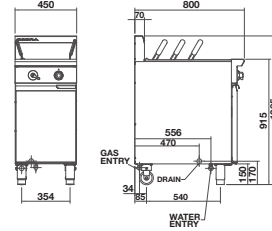

12  
45,450  
£5,165.00

### OPTIONAL EXTRAS – GAS PASTA COOKER

238674	Pasta basket LH – 165mm x 165mm x 180mm	£160.00
238819	Pasta basket RH – 165mm x 165mm x 180mm	£160.00
240516	Conversion kit for gas noodle kit includes basket support tray and 5 noodle baskets	£370.00

## GAS NOODLE COOKER



CN4

450mm NOODLE COOKER

SINGLE PAN

**CN4**  
40 Litre water capacity, mechanical thermostat patented infra-red burner system, 5 stainless steel noodle baskets included

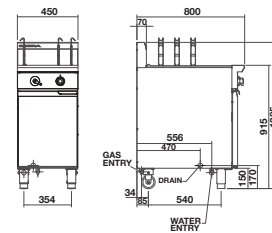

12  
45,450  
£5,165.00

### OPTIONAL EXTRAS – GAS NOODLE COOKER

240507	Noodle basket	£70.00
--------	---------------	--------

# COBRA<sup>®</sup> - MEDIUM DUTY MODULAR COOKING EQUIPMENT

Model	Dimensions	Price (exc. VAT)
-------	------------	------------------

## INFILL BENCHES

### 300mm INFILL BENCH

### LEG STAND



**C300**  
300mm Infill bench  
with leg stand

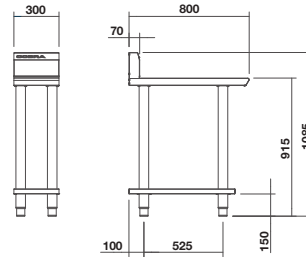

£840.00

C300

### 450mm INFILL BENCH

### LEG STAND



**C450**  
450mm Infill bench  
with leg stand

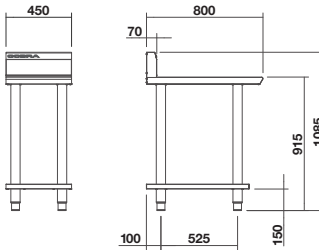

£975.00

C450

### 600mm INFILL BENCH

### LEG STAND



**C600**  
600mm Infill bench  
with leg stand

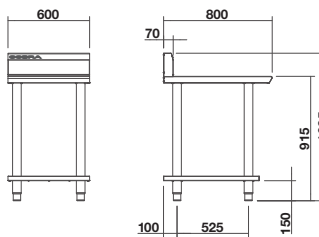

£1,120.00

C600

# INFILL BENCHES

Model	Dimensions	Price (exc. VAT)
-------	------------	------------------

## 900mm INFILL BENCH

## LEG STAND



**C900**  
900mm Infill bench  
with leg stand

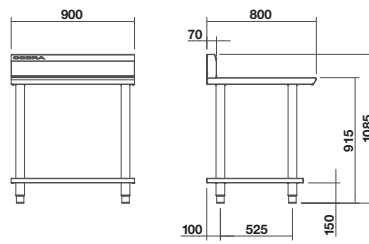

£1,255.00

C900

## 900mm INFILL BENCH

## LEG STAND WITH SALAMANDER SUPPORT



**C900S**  
900mm Infill bench with salamander  
support on leg stand

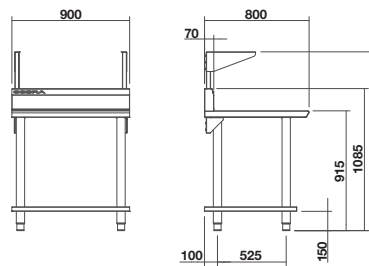

£1,810.00

C900S



20MSERIES

20DSERIES



Reduced footprints, better rack spacing and a bi-directional fan system.\*

POWERFUL PERFORMANCE, SMALLER FOOTPRINT,

\*E22 & E31D4 use single direction fans

# turbofan<sup>®</sup>

TODAY'S INNOVATIVE, EASY TO USE TURBOFAN RANGE HAS BEEN DESIGNED AND MANUFACTURED TO THE HIGHEST SPECIFICATION AND CONTINUES TO PROVIDE A CLASS LEADING SOLUTION FOR EVERY KIND OF CATERING LOCATION. THESE EASY TO USE OVENS HAVE BEEN DESIGNED WITH A CLEAR UNDERSTANDING OF OUR CUSTOMERS NEEDS AND THE CHANGING DEMANDS OF THE CATERING INDUSTRY. DELIVERING OUTSTANDING COOKING, BAKING AND ROASTING PERFORMANCE, USING IMPROVED BI-DIRECTIONAL FAN SYSTEMS THAT ACHIEVE BETTER THAN EVER RESULTS

## FEATURES...

- SPACE SAVING EFFICIENCY
- BI-DIRECTIONAL FAN SYSTEM
- DUAL BI-DIRECTIONAL FAN SYSTEM
- MORE OVENS, MORE APPLICATIONS
- PORTABLE COOKING
- FIELD REVERSIBLE SIDE HINGED DOORS
- SAFE TOUCH VENTED OVEN DOORS
- TOUCH SCREE MODULE
- DIGITAL CONTROL MODELS
- MARKET LEADING TRAY SPACING
- HALOGEN OVEN LAMPS
- MOISTURE INJECTION
- GRILL MODE
- SAFE TOUCH VENTED OVEN DOORS
- VITREOUS ENAMELLED OVEN CHAMBER

[WWW.BLUE-SEAL.CO.UK](http://WWW.BLUE-SEAL.CO.UK)

### 30DSERIES



The ultimate in commercial convection ovens - ideal for baking, roasting and holding.

### PSERIES



Our upgraded range of easy to use Provers/ Holding Cabinets, are smart in design and even smarter in engineering, The eight or twelve tray units come with an auto-fill humidity generator and holding cabinet function mode as standard.

### TSERIES



### HSERIES



## INNOVATIVE FEATURES... IN A CLASS OF ITS OWN.

Dimensions / Power  
(w x d x h)

Options

kW

Price (exc. VAT)

## 20SERIES



**E22M3**

**E22T** Tray 460x330mm £80.00

**E22M3**

### MANUAL ELECTRIC CONVECTION OVEN

Rack capacity: 3  
610mm x 608mm x 552mm  
Electrical requirements:  
230-240V, 50/60Hz,  
1 Phase+N+E, 2.1kW, 9A  
10A cordset supplied

3 x 460mm x 330mm half size sheet pan capacity 2.1  
3 x 2/3 GN pan capacity  
70mm Tray spacing  
Compact 610mm width  
3 Oven wire racks supplied  
Single direction low-velocity fan  
Double Stacking Kit DSK2223C

£2,190.00

£1,035.00



**SK23 STAND** £1,035.00

Stainless steel stand with castors  
W 610mm x D 530mm x H 880mm



**E23M3**

**E22T** Tray 460x330mm £80.00

**E23M3**

### MANUAL ELECTRIC CONVECTION OVEN

Rack capacity: 3  
610mm x 642mm x 607mm  
Electrical requirements:  
230-240V, 50/60Hz,  
1 Phase+N+E, 3.0kW, 12A  
13A cordset fitted

3 x 460mm x 330mm half size sheet pan capacity 3.0  
3 x 2/3 GN pan capacity  
85mm Tray spacing  
Compact 610mm width  
3 Oven wire racks supplied  
Bi-directional reversing fan system  
Double Stacking Kit DSK2223C

£2,480.00

£1,035.00



**SK23 STAND** £1,035.00

Stainless steel stand with castors  
W 610mm x D 530mm x H 880mm



**E23D3**

**E22T** Tray 460x330mm £80.00

**E23D3**

### DIGITAL ELECTRIC CONVECTION OVEN

Rack capacity: 3  
610mm x 642mm x 607mm  
Electrical requirements:  
230-240V, 50/60Hz,  
1 Phase+N+E, 3.0kW, 12A  
13A cordset fitted

3 x 460mm x 330mm half size sheet pan capacity 3.0  
3 x 2/3 GN pan capacity  
85mm Tray spacing  
Compact 610mm width  
3 Oven wire racks supplied  
Bi-directional reversing fan system  
Double Stacking Kit DSK2223C  
Steam injection

£2,605.00

£1,035.00



**SK23 STAND** £1,035.00

Stainless steel stand with castors  
W 610mm x D 530mm x H 880mm



**E27M2**

**E311GAST** Tray 1/1GN 20mm deep £80.00  
**E27FT** Tray 400x600mm £80.00  
**E32UST** Tray 460x660mm £80.00

**E27M2**

### MANUAL ELECTRIC CONVECTION OVEN

Rack capacity: 2  
810mm x 762mm x 607mm  
Electrical requirements:  
230-240V, 50/60Hz,  
1 Phase+N+E, 3.0kW, 12A  
13A cordset supplied

2 x 460mm x 660mm full size sheet pan capacity 3.0  
2 x 600mm x 400mm tray capacity  
85mm Tray spacing  
Compact 810mm width  
2 Oven wire racks supplied  
Bi-directional reversing fan system  
Double Stacking Kit DSK272831C

£2,835.00

£1,035.00



**SK2731N STAND** £1,035.00

Stainless steel stand with castors  
Suits 600mm x 400mm trays and 1/1 GN pans  
W 810mm x D 650mm x H 880mm



**SK2731U STAND** £1,035.00

Stainless steel stand with castors  
Suits 660mm x 460mm pans  
W 810mm x D 650mm x H 880mm

Dimensions / Power (w x d x h)	Options	kW	Price (exc. VAT)
-----------------------------------	---------	----	------------------

## E27D2 DIGITAL ELECTRIC CONVECTION OVEN



Rack capacity: 2 810mm x 762mm x 607mm Electrical requirements: 230-240V, 50/60Hz, 1 Phase+N+E, 3.0kW, 12A 13A cordset supplied	2 x 460mm x 660mm full size sheet pan capacity 3.0 2 x 600mm x 400mm tray capacity 115mm Tray spacing Compact 810mm width 2 Oven wire racks supplied Bi-directional reversing fan system Double Stacking Kit DSK272831C Steam injection	<b>£3,010.00</b>
		<b>£1,035.00</b>

E27D2

E311GAST Tray 1/1GN 20mm deep	£80.00
E27FT Tray 400x600mm	£80.00
E32UST Tray 460x660mm	£80.00



<b>SK2731N STAND</b>	<b>£1,035.00</b>
Stainless steel stand with castors Suits 600mm x 400mm trays and 1/1 GN pans W 810mm x D 650mm x H 880mm	



<b>SK2731U STAND</b>	<b>£1,035.00</b>
Stainless steel stand with castors Suits 660mm x 460mm pans W 810mm x D 650mm x H 880mm	



## E27M3 MANUAL ELECTRIC CONVECTION OVEN

Rack capacity: 3 810mm x 762mm x 607mm Electrical requirements: 230-240V, 50/60Hz, 1 Phase+N+E, 4.7kW, 19.6A No cordset supplied	3 x 460mm x 660mm full size sheet pan capacity 4.7 3 x 600mm x 400mm tray capacity 85mm Tray spacing Compact 810mm width 3 Oven wire racks supplied Bi-directional reversing fan system Double Stacking Kit DSK272831C	<b>£3,200.00</b>
		<b>£1,035.00</b>

E27M3

E311GAST Tray 1/1GN 20mm deep	£80.00
E27FT Tray 400x600mm	£80.00
E32UST Tray 460x660mm	£80.00



<b>SK2731N STAND</b>	<b>£1,035.00</b>
Stainless steel stand with castors Suits 600mm x 400mm trays and 1/1 GN pans W 810mm x D 650mm x H 880mm	



<b>SK2731U STAND</b>	<b>£1,035.00</b>
Stainless steel stand with castors Suits 660mm x 460mm pans W 810mm x D 650mm x H 880mm	



## E27D3 DIGITAL ELECTRIC CONVECTION OVEN

Rack capacity: 3 810mm x 762mm x 607mm Electrical requirements: 230-240V, 50/60Hz, 1 Phase+N+E, 4.7kW, 19.6A No cordset supplied	3 x 460mm x 660mm full size sheet pan capacity 4.7 3 x 600mm x 400mm tray capacity 85mm Tray spacing Compact 810mm width 3 Oven wire racks supplied Bi-directional reversing fan system Double Stacking Kit DSK272831C Steam injection	<b>£3,360.00</b>
		<b>£1,035.00</b>

E27D3

E311GAST Tray 1/1GN 20mm deep	£80.00
E27FT Tray 400x600mm	£80.00
E32UST Tray 460x660mm	£80.00



<b>SK2731N STAND</b>	<b>£1,035.00</b>
Stainless steel stand with castors Suits 600mm x 400mm trays and 1/1 GN pans W 810mm x D 650mm x H 880mm	



<b>SK2731U STAND</b>	<b>£1,035.00</b>
Stainless steel stand with castors Suits 660mm x 460mm pans W 810mm x D 650mm x H 880mm	



## E28M4 MANUAL ELECTRIC CONVECTION OVEN

Rack capacity: 4 810mm x 762mm x 662mm Electrical requirements: 230-240V, 50/60Hz, 1 Phase+N+E, 5.8kW, 25A No cordset supplied	4 x 460mm x 660mm full size sheet pan capacity 5.8 4 x 600mm x 400mm tray capacity 80mm Tray spacing Compact 810mm width 4 Oven wire racks supplied Twin Bi-directional reversing fans Double Stacking Kit DSK272831C	<b>£4,330.00</b>
		<b>£1,035.00</b>

E28M4

E311GAST Tray 1/1GN 20mm deep	£80.00
E27FT Tray 400x600mm	£80.00
E32UST Tray 460x660mm	£80.00



<b>SK2731N STAND</b>	<b>£1,035.00</b>
Stainless steel stand with castors Suits 600mm x 400mm trays and 1/1 GN pans W 810mm x D 650mm x H 880mm	



<b>SK2731U STAND</b>	<b>£1,035.00</b>
Stainless steel stand with castors Suits 660mm x 460mm pans W 810mm x D 650mm x H 880mm	

Dimensions / Power (w x d x h)	Options	kW	Price (exc. VAT)
-----------------------------------	---------	----	------------------



**E28D4**

- E311GAST** Tray 1/1 GN 20mm deep £80.00
- E27FT** Tray 400x600mm £80.00
- E32UST** Tray 460x660mm £80.00

**E28D4 | DIGITAL ELECTRIC CONVECTION OVEN**

Rack capacity: 4 810mm x 762mm x 662mm Electrical requirements: 230-240V, 50/60Hz, 1 Phase+N+E, 5.8kW, 25A No cordset supplied	4 x 460mm x 660mm full size sheet pan capacity 5.6 4 x 600mm x 400mm tray capacity 80mm Tray spacing Compact 810mm width 4 Oven wire racks supplied Twin Bi-directional reversing fans Double Stacking Kit DSK272831C Steam injection	5.6	<b>£4,700.00</b>
---	--	-----	------------------



**SK2731N STAND £1,035.00**  
Stainless steel stand with castors  
Suits 600mm x 400mm trays and 1/1 GN pans  
W 810mm x D 650mm x H 880mm



**SK2731U STAND £1,035.00**  
Stainless steel stand with castors  
Suits 660mm x 460mm pans  
W 810mm x D 650mm x H 880mm



**E931M**

**E931M | ELECTRIC CONVECTION OVEN & 4 ELEMENT COOKTOP**

675mm x 626mm x 800mm Cooktop Single phase 2 x 2kW front and 2 x 1.5kW rear hot plate elements.		7	<b>£5,035.00</b>
Convection Oven Rack capacity: 4 Electrical requirements: 230-240V, 50/60Hz, 1 Phase+N+E, 3.1kW, 12.9A 13A cordset supplied	4 x 1/1 GN tray capacity 80mm Tray spacing Digital display time and temperature controls 4 Oven wire racks supplied Single directional low-velocity fan * Two separate electrical supplies	3.0	

**30SERIES**



**E30M3**

- E311GAST** Tray 1/1 GN 20mm deep £80.00

**E30M3 | MANUAL ELECTRIC CONVECTION OVEN**

Rack capacity: 3 810mm x 616mm x 625mm Electrical requirements: 230-240V, 50/60Hz, 1 Phase+N+E, 2.3kW, 9.5A 13A cordset supplied	3 x 1/1 GN tray capacity 100mm Tray spacing Analogue time and temperature controls 3 Oven wire racks supplied Single directional low-velocity fan Double Stacking Kit DSK272831C	2.3	<b>£2,360.00</b>
---	---	-----	------------------



**SK2731N STAND £1,035.00**  
Stainless steel stand with castors  
1/1 GN pans  
W 810mm x D 650mm x H 880mm



**E31D4**

- E311GAST** Tray 1/1 GN 20mm deep £80.00

**E31D4 | DIGITAL ELECTRIC CONVECTION OVEN**

Rack capacity: 4 810mm x 616mm x 625mm Electrical requirements: 230-240V, 50/60Hz, 1 Phase+N+E, 3.1kW, 12.9A 13A cordset supplied	4 x 1/1 GN tray capacity 80mm Tray spacing Digital display time and temperature controls Grill mode 4 Oven wire racks supplied Single directional low-velocity fan Double Stacking Kit DSK272831C	3.1	<b>£3,280.00</b>
--	---	-----	------------------



**SK2731N STAND £1,035.00**  
Stainless steel stand with castors  
1/1 GN pans  
W 810mm x D 650mm x H 880mm

Dimensions / Power (w x d x h)	Options	kW	Price (exc. VAT)
-----------------------------------	---------	----	------------------



**E33D5**

- E311GAST** Tray 1/1GN 20mm deep **£80.00**
- 236057** Oven rack **£70.00**
- 240550** Heat Shield **£285.00**

**E33D5 | DIGITAL CONVECTION OVEN**

Rack capacity: 5 610mm x 680mm x 730mm	5 x 1/1 GN Tray capacity 85mm Tray spacing Digital time and temperature controls Bi-directional fan 2 speed fan 3 stage cooking function 5 levels of humidity Optional core temp probe Double Stacking Kit DSK33C Oven racks not supplied	6	<b>£4,885.00</b>
Electrical requirements: 230-240V, 50Hz, 1 Phase+N+E, 6kW, 25.7A No cordset supplied			<b>£315.00</b> <b>£1,035.00</b>

- SK33 STAND** **£1,035.00**  
Stainless steel stand with castors  
W 610mm x D 650mm x H 880mm



**E33T5**

- E311GAST** Tray 1/1GN 20mm deep **£80.00**
- 236057** Oven rack **£70.00**
- 240550** Heat Shield **£285.00**

**E33T5 | TOUCH SCREEN ELECTRIC CONVECTION OVEN**

Rack capacity: 5 610mm x 680mm x 730mm	5 x 1/1 GN Tray capacity 85mm Tray spacing Touch screen controls Bi-directional fan 2 speed fan 3 stage cooking function 5 levels of humidity Optional core temp probe Double Stacking Kit DSK33C Oven racks not supplied	6	<b>£7,385.00</b>
Electrical requirements: 230-240V, 50Hz, 1 Phase+N+E, 6kW, 25.7A No cordset supplied			<b>£315.00</b> <b>£1,035.00</b>



- SK33 STAND** **£1,035.00**  
Stainless steel stand with castors  
W 610mm x D 650mm x H 880mm



**E32D4**

- E32UST** Tray 460x660mm **£80.00**
- 240466** Heat Shield **£300.00**

**E32D4 | DIGITAL ELECTRIC CONVECTION OVEN**

Rack capacity: 4 735mm x 810mm x 730mm	4 x 460mm x 660mm full size sheet pan capacity 4 x 600mm x 400mm tray capacity 110mm Tray spacing Compact 735mm width 4 Oven wire racks supplied Bi-directional fan motor 3 stage cooking function 5 levels of humidity setting 2 speed bi-directional reversing fan system Double Stacking Kit DSKE32C Optional core temp probe Steam injection	6.5	<b>£5,805.00</b>
Electrical requirements: 230-240V, 50/60Hz, 1 Phase+N+E, 6.5kW, 27A No cordset supplied			<b>£1,300.00</b> <b>£315.00</b>



- SK32 STAND** **£1,035.00**  
Stainless steel stand with castors  
W 735mm x D 825mm x H 880mm



**E32T4**

- E32UST** Tray 460x660mm **£80.00**
- 240466** Heat Shield **£300.00**

**E32T4 | TOUCH SCREEN ELECTRIC CONVECTION OVEN**

Rack capacity: 4 735mm x 810mm x 730mm	4 x 460mm x 660mm full size sheet pan capacity 4 x 600mm x 400mm tray capacity 110mm Tray spacing Compact 735mm width 4 Oven wire racks supplied Bi-directional fan motor 3 stage cooking function 5 levels of humidity setting 2 speed bi-directional reversing fan system Double Stacking Kit DSKE32C Optional core temp probe Steam injection	6.5	<b>£6,695.00</b>
Electrical requirements: 230-240V, 50/60Hz, 1 Phase+N+E, 6.5kW, 27A No cordset supplied			<b>£1,300.00</b> <b>£315.00</b>



- SK32 STAND** **£1,035.00**  
Stainless steel stand with castors  
W 735mm x D 825mm x H 880mm

Dimensions / Power (w x d x h)	Options	kW	Price (exc. VAT)
-----------------------------------	---------	----	------------------



**G32D4**

<b>E32UST</b> Tray 460x660mm	<b>£80.00</b>
<b>240549</b> Heat Shield	<b>£315.00</b>

**G32D4**

**DIGITAL GAS CONVECTION OVEN**



Rack capacity: 4 735mm x 810mm x 910mm	4 x 460mm x 660mm full size sheet pan capacity 1 phase 4 x 600mm x 400mm tray capacity 110mm Tray spacing Compact 735mm width 4 Oven wire racks supplied Bi-directional fan motor Double Stacking Kit <b>DSKG32C</b> Steam injection Optional core temp. probe	£7,095.00
Electrical requirements: 230-240V, 50/60Hz, 1 Phase+N+E, 0.5A 10A cordset fitted		£1,300.00
Gas requirements: 35 MJ/hr burner rating. Natural, Propane/Butane models Unit supplied complete with gas type conversion kit Gas connection 1/2" NPT male 10kW equivalent gas power		£315.00
		<b>SK32 STAND</b> £1,035.00 Stainless steel stand with castors W 735mm x D 825mm x H 880mm



**E35D6**

<b>E35GBT</b> Tray 460x760mm	<b>£80.00</b>
------------------------------	---------------

**E35D6**

**Full Size Digital / Electric Convection Oven**



W 910mm x D 1022mm x H 871mm including 76mm feet 6 x 406mm x 736mm / 16" x 29" tray capacity 6 x 457mm x 762mm / 18" x 30" tray capacity 105mm tray spacing 12kW heating power Electronic controls with Digital Time and Temperature display 3-phase model 400-415v, 50Hz, 12.5kW, 3P+N+E, 17.4A/ph	12.5	£10,455.00
Optional M236060 Core Temperature Probe Kit Stand SK35 • Stacking Kit DSK35		£315.00 £1,410.00 £1,240.00

## P SERIES PROVER/HOLDING CABINETS

**STANDARD FEATURES**

**P8M / P10M / P12M**

**OPTIONAL EXTRAS**

- Dual function prover and holding cabinet
- Designed for individual use or system installed with Turbofan 32D convection ovens
- Low velocity circulation fan system
- Humidity level control
- Compact 735mm width
- Full double skin construction
- Auto water fill system with optional integrated water filter kit

- Continuous door seal
- Side hinged door
- Off / Prove / Hold mode selection
- Mechanical thermostat 20-85°C
- Dual halogen cabinet interior lamps
- Cabinet temperature display thermometer
- 4 dia. 76mm castors with 2 front castors dual wheel and swivel lock, 2 rigid rear castors
- 100% recyclable packaging

**234347** Filter Head Kit **£350.00**

This kit supplies the cartridge mounting head assembly plus all associated plumbing/fittings for installation to P12 provers. Also includes double check/pressure reducing valve and 2 metres of tubing for connection to supply.

**234562** Filter Cartridge P124BN CUNO **£275.00**

Filter cartridge itself, for connection to above installation kit.

**P8M**

- 8 Full size sheet pan capacity
- 8 EN 600 x 400 tray capacity

- 16 Half size sheet pan capacity
- 76mm Tray spacing

**P12M**

- 12 Full size sheet pan capacity
- 12 EN 600 x 400 tray capacity

- 24 Half size sheet pan capacity
- 74mm Tray spacing



**P8M**

**P8M**

**AUTO ELECTRIC PROVER & HOLDING CABINET**



Rack capacity: 8 735mm x 810mm x 914mm Electrical requirements: 230-240V, 50/60Hz, 1 Phase+N+E, 1.5kW, 6.3A 10A cordset fitted	Dual function prover and holding cabinet Designed for individual use or system installed with Turbofan 32D convection ovens 8 Full size sheet pan capacity 16 Half size sheet pan capacity 8 EN 600 x 400 tray capacity P/No. 235445 76mm Tray spacing Compact 735mm width	1.5	£5,440.00
	<b>234841</b> Stacking Kit to E32D4		£195.00
	<b>235445</b> Racking kit 600mm x 400mm trays		£585.00

Dimensions / Power (w x d x h)	Options	kW	Price (exc. VAT)
-----------------------------------	---------	----	------------------



P10M

P10M	AUTO ELECTRIC PROVER & HOLDING CABINET		
Rack capacity: 10 610mm x 680mm x 1015mm Electrical requirements: 230-240V, 50/60Hz, 1 Phase+N+E, 1.5kW, 6.3A 10A cordset supplied	Dual function prover and holding cabinet Designed for individual use or system installed with Turbofan E33D convection oven 10 1/1 GN pan capacity 74mm Tray spacing Compact 610mm width	1.5	£4,795.00
	<b>236617</b> Stacking Kit to E33D5		£195.00



P12M

P12M	AUTO ELECTRIC PROVER & HOLDING CABINET		
Rack capacity: 12 735mm x 810mm x 1129mm Electrical requirements: 230-240V, 50/60Hz, 1 Phase+N+E, 1.9kW, 8.5A 10A cordset supplied	Dual function prover and holding cabinet Designed for individual use or system installed with Turbofan 32D convection ovens 12 Full size sheet pan capacity 24 Half size sheet pan capacity 12 EN 600 x 400 tray capacity 74mm Tray spacing Compact 735mm width	1.9	£5,980.00
	<b>234841</b> Stacking Kit to E/G32D4		£195.00
	<b>235445</b> Racking kit 600mm x 400mm trays		£585.00



P85M8

P85M8	PROVER/HOLDING CABINET		
W 910mm x D 880mm x H 914mm including dia. 76mm castors • 8 457mm x 762mm / 18" x 30" tray capacity • 76mm tray spacing • 1.5kW heating power • Optional M236060 Core Temperature Probe Kit • Stacking kit 239704 P85M8 with E35D6		1.5	£5,440.00
			£315.00
			£195.00



P85M12

P85M12	PROVER/HOLDING CABINET		
W 910mm x D 810mm x H 1129mm including dia. 76mm castors • 12 457mm x 762mm / 18" x 30" tray capacity • 74mm tray spacing • 1.9kW heating power • Optional M236060 Core Temperature Probe Kit • Stacking kit 239704 P85M12 with E35D6		1.9	£5,980.00
			£315.00
			£195.00

# turbofan® HOT HOLDING CABINETS

	MODEL	DETAILS	Gas Power kW	Price (exc. VAT)
	<b>H8D-UC</b>	<b>HOLDING CABINET</b> W 610mm x D 680mm x H 810mm • 8 x 1/1 GN tray capacity • 74mm tray spacing • 1.2kW heating power • Electronic digital control panel	1.2	£5,200.00
<b>H8D-UC</b>				
	<b>H8D-FS-UC</b>	<b>HOLDING CABINET</b> W 735mm x D 810mm x H 810mm • 8 full size 460mm x 660mm / 18" x 26" sheet pan capacity • 74mm tray spacing • 1.9kW heating power • Electronic digital control panel	1.9	£5,330.00
<b>H8D-FS-UC</b>				
	<b>H10D-FS</b>	<b>HOLDING CABINET</b> W 735mm x D 810mm x H 1015mm • 10 full size 460mm x 660mm / 18" x 26" sheet pan capacity • 74mm tray spacing • 1.9kW heating power • Electronic digital control panel	1.9	£5,610.00
<b>H10D-FS</b>				
	<b>H10D</b>	<b>HOLDING CABINET</b> W 610mm x D 1015mm x H 680mm • 10 1/1 GN pan capacity • 74mm tray spacing • 1.2kW heating power • Electronic digital control panel	1.2	£5,355.00
<b>H10D</b>				
	<b>H10T</b>	<b>HOLDING CABINET</b> W 610mm x D 1015mm x H 680mm • 10 1/1 GN pan capacity • 74mm tray spacing • 1.2kW heating power • Electronic touch sensitive control panel	1.2	£5,755.00
<b>H10T</b>				
	<b>EHT10-L</b>	<b>TOUCH SCREEN ELECTRIC HUMIDIFIED HOLDING CABINET</b> W 610mm x D 680mm x H 1015mm • 10 1/1 GN pan capacity • 2.3kW heating power • Electronic touch sensitive control panel	2.3	£7,045.00
<b>EHT10-L</b>				

**OPTIONAL EXTRAS**

<b>SKEHT10</b>	Stainless steel stand with castors (2 with swivel lock) to suit EHT10-L model W610mm x D 727mm x H 609mm	<b>£735.00</b>
<b>237472</b>	Double stacking kit to suit E33/EHT10-L models	<b>£245.00</b>
<b>234347</b>	Filter head kit This kit supplies the cartridge mounting head assembly plus all associated plumbing/fittings for installation to P8/P12/P10/P85 provers. Also includes double check/pressure reducing valve and 2 metres of tubing for connection to supply	<b>£350.00</b>
<b>234562</b>	Filter Cartridge P124BN CUNO Filter cartridge itself for connection to above installation kit	<b>£275.00</b>

**turbofan**® VENTLESS HOODS - suitable for single oven use only

**VH SERIES**



**VH32**

Model	Details	Price (exc. VAT)
<b>VH32</b>	<b>VENTLESS HOOD FOR E32D4/E32T4 OVENS</b>	<b>£6,890.00</b>
	W 742mm x D 1015mm x H 340mm • 230-240V, 50/60Hz, 1 Phase+N+E, 0.5A • 10A plug cordset fitted	



**VH33**

<b>VH33</b>	<b>VENTLESS HOOD FOR E33D5/E33T5 OVENS</b>	<b>£6,705.00</b>
	W 617mm x D 890mm x H 340mm • 230-240V, 50/60Hz, 1 Phase+N+E, 0.5A • 10A plug cordset fitted	



**VH35-30**

<b>VH35-30</b>	<b>VENTLESS HOOD FOR E35D6-30/E35T6-30 OVENS</b>	<b>£7,915.00</b>
	W 917mm x D 1145mm x H 340mm • 230-240V, 50/60Hz, 1 Phase+N+E, 1.0A • 10A plug cordset fitted	

**OPTIONAL EXTRAS – CARBON FILTER**

<b>H11715</b>	<b>Carbon Filter</b>	<b>£30.00</b>
---------------	----------------------	---------------

**STANDARD FEATURES**

- Ventless oven hood - no vent connection or canopy required
- 3-stage filtering with condensing heat exchanger; 1st stage grease filter baffle, 2nd stage mesh particle filter, 3rd stage odour reduction charcoal filter
- Oven vent condensing heat exchanger reducing heat emissions
- Condensate collection to self-contained collection pan  
No waste drain connection needed or condensate collection to waste drain. No manual emptying of condensate collection pan required
- Hood control interlock with oven - cannot operate without hood opening
- Low speed fan operation - reduced noise
- Automatic high speed fan when oven door is open
- User replacement charcoal filter
- Removable grease baffle and mesh filters
- 240V, 10A plug cordset electrical connection
- Hood installation kits are required to install VH Series hoods on Turbofan ovens

# turbofan<sup>®</sup>

## COMBI

Turbofan Combi Steamers offer the ultimate in convenience, versatility and control, enabling you to deliver a wide range of foods to the highest standards without the need for large appliances.

From bread and pizza, through seafood, meats and vegetables to dessert, Turbofan Combi provides convection, steam or combination convection/steam cooking, with a choice of manual or touch screen models.

With refined lines and sophisticated design the entirely flat 40 Series lets you make the most of your space, be it behind the scenes or out in front of the crowd. Tuck it away in the bar area or have it pride of place in the open kitchen – either way you'll be happy to see this high performer deliver the goods time and time again.

- Choice of 6 models – 3 manual and 3 touch screen
- 7kW – 14kW heating power
- 30 – 80 covers per load
- 70mm tray spacing
- 5, 7 or 10 tray capacity
- 600mm x 400mm trays
- Range of accessories and options

Touch screen models also feature:-

- 2 speed fan.
- Manual cooking with three cooking modes – Convection (30°C-260°C), Steam (30°C-130°C), Combi (30°C-260°C).
- Autoclima® system that automatically manages the perfect climate in the cooking chamber.
- MULTILEVEL PLUS - multi-level function on each shelf means doubling production capacity (patented).
- High-definition 7-inch capacitive LCD colour touch screen function – configurable based on user preferences.
- Programmable modes: create and save a recipe with its cooking methods in an automatic sequence (up to 15 cycles) giving each program its own name, picture and information.
- Intelligent recognition of recipes in multilevel folders.
- ICS (Interactive Cooking System), an automatic cooking system for preset recipes including their history, ingredients, cooking accessory, procedure, automatic cooking program and picture.
- Automatic one touch cooking (ICS).
- Auto reverse (automatic inversion of the direction of the fan) for perfectly uniform cooking.
- ECOVAPOR – automatic control of the steam saturation in the cooking chamber.
- ECOSPEED – oven optimizes and controls the delivery of energy to maintain correct cooking temperature.
- Core temperature probe included.
- Automatic cleaning system LCS (Liquid Clean System) with built-in tank and automatic dispensing.
- USB connection to download HACCP data, software update and cooking program management.
- Wi-Fi connectivity.
- Low consumption LED cooking chamber lighting.
- Self-diagnostic with smart error viewing.
- Door with rear ventilation, double tempered glass front with air chamber and interior heat-reflecting glass.
- Internal glass that folds for easy cleaning.
- Cooking chamber in 1mm thick AISI 304 stainless steel with fully rounded edges for best airflow and easy cleaning.

We strongly recommend that site has its water tested and suitable water treatment installed as required.

## MANUAL



EC40M5



EC40M7



EC40M10

## TOUCH SCREEN







EC40T5



EC40T7



EC40T10

Dimensions / Power (w x d x h)	Options	kW	Price (exc. VAT)
	<b>EC40M5</b>   <b>5 Tray Manual Electric Combi Oven</b>		
	W 777mm x D 835mm x H 777mm • 5 x 1/1 GN tray capacity • 5 x 600mm x 400mm tray capacity • 70mm tray spacing • 7.25kW heating power • 30 covers per load • Electromechanical controls Stand SK40A Electrical requirements: 400-415V, 50Hz, 3-Phase+N+E, 7.25kW @ 400V, 11A/ph 230-240V, 50Hz, 1-Phase+N+E, 7.25kW, 32A	7	£7,130.00  £1,035.00
	<b>EC40T5</b>   <b>5 Tray TOUCH SCREEN Electric Combi Oven</b>		
	Rack capacity: 5 777mm x 744mm x 723mm Weight: 74kg Electric direct steam version • Compact 777mm wide • 5 x 1/1 GN tray capacity • 5 x 600mm x 400mm tray capacity • 70mm tray spacing • 7.25kW heating power Stand SK40A Electrical requirements: 400-415V, 50Hz, 3-Phase+N+E, 7.25kW @ 400V, 11A/ph 230-240V, 50Hz, 1-Phase+N+E, 7.25kW, 32A	7	£8,600.00  £1,035.00
	<b>EC40M7</b>   <b>7 Tray Manual Electric Combi Oven</b>		
	W 777mm x D 835mm x H 942mm • 7 x 1/1 GN tray capacity • 7 x 600mm x 400mm tray capacity • 70mm tray spacing • 12kW heating power • 50 covers per load • Electromechanical controls Stand SK40A Electrical requirements: 400-415V, 50Hz, 3-Phase+N+E, 12.5kW @ 400V, 18A/ph	12	£8,810.00  £1,035.00
	<b>EC40T7</b>   <b>7 Tray TOUCH SCREEN Electric Combi Oven</b>		
	Rack capacity: 7 777mm x 744mm x 887mm Weight: 90kg Electric direct steam version • Compact 777mm wide • 7 x 1/1 GN tray capacity • 7 x 600mm x 400mm tray capacity • 70mm tray spacing • 12.5kW heating power Stand SK40A Electrical requirements: 400-415V, 50Hz, 3-Phase+N+E, 12.5kW @ 400V, 18A/ph	12	£10,305.00  £1,035.00
	<b>EC40M10</b>   <b>10 Tray Manual Electric Combi Oven</b>		
	W 777mm x D 835mm x H 1152mm • 10 x 1/1 GN tray capacity • 10 x 600mm x 400mm tray capacity • 70mm tray spacing • 14.5kW heating power • 80 covers per load • Electromechanical controls Stand SK40-10A Electrical requirements: 400-415V, 50Hz, 3-Phase+N+E, 14.5kW @ 400V, 22A/ph	14	£9,890.00  £1,035.00

**EC40T10**

Dimensions / Power (w x d x h)	Options	kW	Price (exc. VAT)
<b>EC40T10</b>	<b>10 Tray TOUCH SCREEN Electric Combi Oven</b>		
Rack capacity: 10 777mm x 744mm x 1097mm Weight: 104kg	Electric direct steam version • Compact 777mm wide • 10 x 1/1 GN tray capacity • 10 x 600mm x 400mm tray capacity • 70mm tray spacing • 14.5 kW heating power	14	<b>£11,695.00</b>
	Stand SK40-10A		<b>£1,035.00</b>
Electrical requirements: 400-415V, 50Hz, 3-Phase+N+E, 14.5kW @ 400V, 22A/ph			

**OPTIONAL EXTRAS FOR COMBI OVENS**

Model	Description	Price (exc. VAT)
CP004	Multi-point core temperature probe - Turbofan Combi	£435.00
C1100STEAM	Water treatment kit	£1,050.00
PKE044	5 on 5, 5 on 7, 5 on 10 stacking kit	£750.00
PKE064	7 on 7 stacking kit	£750.00
ISR055	Low Stand 5 on 5, 5 on 7	£315.00
PSR444	Stand for 5 on 5 only	£605.00
3.64.0029	Stainless Steel Grid	£95.00
E311GAST	20mm SS GN tray	£80.00
T1104	40mm SS GN tray	£85.00
T1106	65mm SS GN tray	£95.00
F1102	20mm perforated SS GN tray	£80.00
F1104	40mm perforated SS GN tray	£95.00
F1106	65mm perforated SS GN tray	£125.00
F1110	100mm perforated SS GN tray	£155.00
F1115	150mm perforated SS GN tray	£230.00
S1102	20mm Enameled alloy stew pan	£90.00
S1104	40mm Enameled alloy stew pan	£105.00
S1106	65mm Enameled alloy stew pan	£125.00
R1104	1.5Kg fry basket	£155.00
AT02	20mm stir fry pan, non-stick with sides	£100.00
AT04	40mm stir fry pan, non-stick with sides	£125.00
AT06	65mm stir fry pan, non-stick with sides	£130.00
AF11	Perforated nonstick aluminium tray	£95.00
AT11	Non-stick aluminium tray	£90.00
APLR11	Non-stick aluminium pizza grill, ridged	£340.00
GV110	Square grid non-stick vegetable grill	£170.00
GS111	4 x 52cm skewer grill	£85.00
SD052	52cm skewer	£40.00
GS112	8 x 23cm skewer grill	£95.00
GC230	Meat/fish grill non-stick	£230.00
SG11C	Speedy grill non-stick	£415.00
SAM55	SS lamb/piglet spit 12kg max 550mmh	£330.00
TF106	Non-stick bullseye, 6 pot fried eggs	£130.00
TF223	Non-stick 2 x 200mm omlette pan	£130.00
P1108	8 x chicken spit	£90.00
PS1108	Non-stick 8 x 1.5kg speedy chicken pan	£305.00
PS1106	Non-stick 6 x 2.5kg speedy chicken pan	£305.00
PKC04	Extraction Hood	£3,120.00
PKC04F	Flat extraction hood	£3,055.00
PKC04S	Double stack extraction hood	£3,690.00
CCER90	Steam collector for external extraction	£600.00
SN	Energy saving system connection	£330.00
DSP	Display control panel protection	£75.00
CDL05	Detergent cartridge 5ltr for auto wash units	£145.00
	Opposite hinge door (factory fit only)	£200.00

# PIZZA & BAKERY EQUIPMENT

Dimensions / Power (w x d x h)	Options	kW	Price (exc. VAT)
-----------------------------------	---------	----	------------------



**430-EM**

430-EM	ELECTRIC PIZZA OVEN		
	430-EM electric pizza oven	4.4	£2,650.00
Dimensions: mm (w x d x h) External: 882 x 827 (978mm including handle) x 343 (390mm including vent) Internal: 630 x 630 x 113 Pizza capacity: 4 x 12 inch pizzas. Net weight: 100kg Single Phase - 1 x 4.4kW electrical supply			
	<b>BSPZ01</b> - Steel stand with adjustable feet		£1,035.00

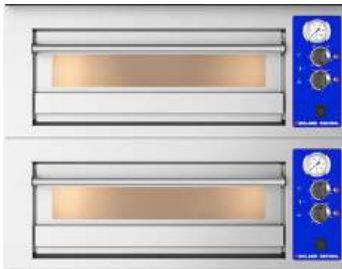

**830-EM**

830-EM	ELECTRIC PIZZA OVEN		
	830-EM electric pizza oven	8.8	£4,185.00
Dimensions: mm (w x d x h) External 882 x 827 (978mm including handle) x 686 (773mm including vent) Internal 630 x 630 x 113 per deck Pizza capacity: 4 x 12 inch pizzas per deck. Net weight: 170kg Single Phase - 2 x 4.4kW electrical supplies			
	<b>BSPZ01</b> - Steel stand with adjustable feet		£1,035.00



**TLV45Touch**

TLV45Touch	CONVEYOR OVEN		
	TLV45Touch conveyor oven Forced air for even baking	9.8	£12,410.00
Dimensions: mm (w x d x h) External: 1440 x 950 x 575 Internal: 740 x 490 x 850 Belt width: 45cm Pizza capacity: 30cm pizza 50/hr 45cm pizza 18/hr 60 x 40cm pizza 9/hr Net weight: 190kg Three Phase - 1 x 9.8kW electrical supply			
	<b>BSPZ02</b> - Steel stand with adjustable feet Dimensions mm (w x d x h): 741 x 810 x 950		£1,085.00
	<b>BSPZ03</b> - Low stand for stacking x 3 TLV45 conveyor ovens Dimensions mm (w x d x h): 810 x 741 x 200		£1,100.00



**BM10**

BM10	PLANETARY MIXER		
	10 litre mixer	3	£2,550.00
Dimensions: mm (w x d x h) 400 x 450 x 630 (stand foot print) Capacity 10 litres Net weight: 62kg Supplied with 3-pin 13A plug			

## PIZZA & BAKERY EQUIPMENT

Dimensions (mm) / Power (w x d x h)	Options	kW	Price (exc. VAT)
--	---------	----	------------------



**BM20**

<b>BM20</b>	<b>HEAVY DUTY MIXER</b>			
515 (incl. handle) x 518 x 879 Capacity 20 litres Net weight: 98kg Supplied with 3-pin 13A plug	20 litre mixer	3		<b>£3,545.00</b>



**FX201M**

<b>FX201M</b>	<b>SPIRAL DOUGH MIXER single speed with Caster Kit</b>			
427 x 740 x 734 Height: (1119mm with feet. Add 65mm if using casters) Capacity: 30 litres Net weight: 79kg Supplied with 3-pin 13A plug	30 litre single speed spiral mixer	0.75		<b>£3,220.00</b>



**FX202M**

<b>FX202M</b>	<b>SPIRAL DOUGH MIXER two speed with Caster Kit</b>			
427 x 740 x 734 Height: (1119mm with feet. Add 65mm if using casters) Capacity: 30 litres Net weight: 79kg Supplied with 3-pin 13A plug	30 litre two speed spiral mixer	0.75		<b>£4,155.00</b>



**PF33**

<b>PF33</b>	<b>HEATED PIZZA PRESS</b>			
410 x 550 x 780 Net weight: 119kg 1-phase 230V 50Hz 16A	Heated pizza press for forming pizza dough bases up to 33cm	3.30		<b>£7,740.00</b>

# WARE WASHING EQUIPMENT

Dimensions / Power	Options	kW	Price (exc. VAT)
--------------------	---------	----	------------------

SG4E2



**SG4E2** | **GLASS WASHER** ⚡

Dimensions: mm (w x d x h) External 460 x 521 x 680 400mm x 400mm rack size Includes rinse aid detergent and drain pumps		2.66	£2,535.00
Pedestal stand			£370.00

SG45E2



**SG45E2** | **GLASS WASHER** ⚡

Dimensions: mm (w x d x h) External 530 x 600 x 755 450mm x 450mm rack size Includes rinse aid detergent and drain pumps		3.78	£3,530.00
Pedestal stand			£500.00

SG5EC2



**SG5EC2** | **GLASS WASHER** ⚡

Dimensions: mm (w x d x h) External 600 x 600 x 820 500mm x 500mm rack size Includes rinse aid detergent and drain pumps	<b>SG5EC2</b>	3.78	£3,350.00
	<b>SG5EC2-D</b> - with integral water softener	3.78	£3,485.00
Pedestal stand			£500.00

SD5EC2



**SD5EC2** | **DISH WASHER** ⚡

Dimensions: mm (w x d x h) External 600 x 600 x 820 500mm x 500mm rack size Includes rinse aid detergent and drain pumps	<b>SD5EC2</b>	3.78	£3,350.00
	<b>SD5EC2-D</b> - with integral water softener	3.78	£3,485.00
Pedestal stand			£500.00

SD5ECBT2



**SD5ECBT2** | **DISH WASHER** ⚡

Dimensions: mm (w x d x h) External 600 x 600 x 820 500mm x 500mm rack size Includes rinse aid detergent and drain pumps	<b>SD5ECBT2</b>	6.45	£4,050.00
	<b>SD5ECBT2-D</b> - with integral water softener	6.45	£4,180.00
Pedestal stand			£500.00
Class 'A' air gap breaktank model			

# WARE WASHING EQUIPMENT

Dimensions / Power	Options	kW	Price (exc. VAT)
--------------------	---------	----	------------------

SH55EBT



SH55EBT	HIGH VOLUME HOOD WASHER		
---------	-------------------------	--	--

Dimensions: mm (w x d x h) External 710 x 735 x 1450 lowered 1860 raised.	<b>SH55EBT</b> high volume hood washer single phase	6.75	£6,220.00
	<b>SH55EDBT</b> single phase with integral water softener	6.75	£6,800.00
	<b>SH55EBT</b> high volume hood washer 3-phase	10	£6,220.00
	<b>SH55EDBT</b> 3-phase with integral water softener	10	£6,800.00
	<b>55068</b> Stainless steel wings		£465.00 (each)

Features: Twin wash cycle and integral break tank.  
Rack output: 30 per hour

\* Model Includes rinse aid detergent and drain pumps.

SH120EBT



SH120EBT	HIGH VOLUME HOOD WASHER		
----------	-------------------------	--	--

Dimensions: mm (w x d x h) External 710 x 740 x 1450 lowered 1860 raised.	<b>SH120EBT</b> high volume hood washer (3-phase only)	10.1	£7,760.00
	<b>SH120EDBT</b> – with integral water softener	10.1	£8,345.00
	<b>55068</b> Stainless steel wings		£465.00 (each)

Features: Class "A" Air Gap, integral break tank and has three wash programmes.  
Basket size: 500mm.  
Washing capacity: up to 1200 plates per hour

\* Model Includes rinse aid detergent and drain pumps.

WATER TREATMENT KIT			
---------------------	--	--	--

<b>C1100STEAM</b>	Water treatment kit		£1,050.00
-------------------	---------------------	--	-----------

Manual water softeners	<b>WS08</b>	8	£295.00
	<b>WS12</b>	12	£330.00
	<b>WS16</b>	16	£420.00

The supply of goods by Blue Seal Limited (Blue Seal) to you is made on the following terms and conditions (Contract Terms): Your attention is particularly drawn to the exclusions and limitations of liability at clause 14.

## 1. GENERAL

- 1.1 Please read these Contract Terms carefully before you submit Your Order (as defined in clause 1.6 below) and when reviewing the details of your order that will be set out in the Order Confirmation (as defined in clause 3.1 below).
- 1.2 These Contract Terms tell you about Blue Seal, how Blue Seal will provide goods to you, how you and Blue Seal may change or end the contract, what to do if there is a problem and other important information. If you think that there is a mistake in these Contract Terms, please contact Blue Seal to discuss.
- 1.3 The seller is Blue Seal Limited (Company No. 03437267) and Blue Seal's registered address is at Unit 67 Gravelly Industrial Park, Erdington, Birmingham, West Midlands. B24 8TQ. Blue Seal's registered VAT number is 705397036.
- 1.4 You can contact Blue Seal by telephoning Blue Seal's customer service team at 0121 327 5575 or by writing to Blue Seal at spares@blue-seal.co.uk or Unit 67, Gravelly Industrial Park, Gravelly Park, Erdington, Birmingham B24 8TQ.
- 1.5 Details of the goods available for purchase can be found at www.blue-seal.co.uk (Site) and within our advertising brochures. The Site includes all web pages under or forming part of the domain name blue-seal.co.uk.
- 1.6 You may order goods sold by Blue Seal by contacting us (in writing, by email or via telephone) confirming the goods you would like to purchase as detailed on our Site or in our advertising brochures (Your Order).
- 1.7 By submitting Your Order you confirm that you have read and understood these Contract Terms and you agree to these Contract Terms, in addition to any terms of use and privacy policy that may be applicable to the Site.
- 1.8 These Contract Terms are the only terms and conditions on which Blue Seal will supply goods to you and will apply to the exclusion of all other terms and conditions including any terms and conditions which you purport to apply under any purchase order, confirmation of order or similar document (whether or not such document is referred to in the contract) and any terms and conditions which may otherwise be implied by trade, custom, practice or course of dealing.
- 1.9 Blue Seal amends these Contract Terms from time to time. Whilst Blue Seal will endeavour to contact existing customers to inform them of changes to these Contract Terms prior to any change coming into effect, you are responsible for familiarising yourself with the most up to date Contract Terms prior to placing Your Order. The most up to date Contract Terms can be found on our Site and in our most recent advertising brochures. Every time you order goods from Blue Seal, the Contract Terms in force at the time of your order will apply to the contract between you and Blue Seal.
- 1.10 These Contract Terms are only in the English language.
- 1.11 You confirm that you have authority to bind any business on whose behalf you purchase goods.

## 2. THE GOODS

- 2.1 Blue Seal will be entitled at any time to:
- 2.1.1 vary the design, finish or specification of the goods and/or their packaging; and/or
- 2.1.2 substitute any materials or parts which are used in goods and which are unavailable for any reason with alternative materials or parts, to the extent that:
- 2.1.3 this does not materially affect their quality or performance; or
- 2.1.4 this is necessary to comply with health and safety or other legal requirements.
- 2.2 The contract is not a sale by sample.
- 2.3 With the exception of the specification, all samples, drawings, descriptive and illustrative matter and advertising issued or published by Blue Seal whether in advertising brochures, websites, other promotional material or otherwise are for the sole purpose of giving an approximate idea of the relevant good(s).

## 3. QUOTATIONS AND ORDERS

- 3.1 Further to you submitting Your Order, Blue Seal will review the details of Your Order and if acceptable, send you an order confirmation email (Order Confirmation). The Order Confirmation is an acceptance of Your Order.
- 3.2 The Order Confirmation is issued on the basis that the terms governing the contract between the parties for the supply of goods detailed in the Order Confirmation are these Contract Terms.
- 3.3 Blue Seal may refuse to issue an Order Confirmation in response to Your Order, without liability to you if:
- 3.3.1 a good in that order is not available;
- 3.3.2 there is an error in the price or the description of the good posted on the Site and/or in our advertising brochures;
- 3.3.3 the order triggers fraud prevention protocols; or
- 3.3.4 Blue Seal believes that to do so is otherwise necessary or expedient.
- 3.4 If Blue Seal refuse to issue an Order Confirmation in response to Your Order, then it will endeavour to notify you of that rejection at the time you submit Your Order or within a reasonable time thereafter. If you have already paid for the goods, Blue Seal will refund you the full amount including any delivery costs charged as soon as possible.
- 3.5 Our contract for the supply of goods detailed in the Order Confirmation will come into force when we send to you the Order Confirmation.

- 3.6 If you consider there to be any mistakes, omissions or inaccuracies in the details set out in the Order Confirmation, or if you wish to amend any aspect of the order details, you will be required to contact us as soon as possible so any amendments to the order details can be agreed between the parties. If the parties are unable to agree the amendments, the contract will terminate and Blue Seal will not proceed with processing the Order. In circumstances where the parties agree amendments, these will be agreed subject to these Contract Terms continuing to apply to the contract to supply the goods (subject to any amendments agreed).
- 3.7 Blue Seal also reserves the right to refuse to fulfil any orders that you may have placed based on information on the Site and/or in our advertising brochures that may contain errors or inaccuracies, including, without limitation, errors, inaccuracies or out-of-date information regarding pricing, shipping, payment terms, or return policies. In these circumstances, Blue Seal will terminate the contract between the parties.
- 3.8 Each order placed for good(s) results in a separate binding contract between you and Blue Seal for the supply of those good(s).
- 3.9 For each order accepted by Blue Seal, Blue Seal will supply the good(s) in that order to you in accordance with these Contract Terms.
- 3.10 You may elect to collect the good(s) you order, or to have them delivered to a nominated delivery address. A fee may apply (see clauses 4 and 7 below).
- 3.11 The Site and/or our advertising brochures may contain typographical errors or other errors or inaccuracies and may not be complete or current. Blue Seal reserves the right to correct any errors, inaccuracies or omissions and to change or update information at any time without notice.
- 3.12 You consent to receive sales invoices electronically for all orders. Electronic invoices will be emailed to the email address provided by you in relation to the each order.
- 3.13 Blue Seal reserves the right to charge a fee of 20% for the cancellation of any order or the return of any goods. The fee will be based on the value of the order or the sale price of the goods as the case may be. The parties agree that the fee, if charged, constitutes a genuine pre-estimate of Blue Seal's loss and a proportionate amount to protect the interests of Blue Seal arising from the cancellation or return of goods and will not be regarded as penalty provisions. The return of goods will only be permitted in circumstances where the goods are returned in a new and unused condition, and the goods are returned within 14 days of delivery (as described in clause 7).
- 3.14 In addition to the fee payable under clause 3.13, where you cancel or return any "spare part goods", Blue Seal reserves the right to charge you an engineering test fee to cover the costs for testing to ensure they meet the necessary safety standards for resale. If requested, Blue Seal will provide an estimate of the fees likely to be incurred prior to undertaking this testing (such a request to be made at the same time the "spare part goods" are returned). For the purposes of this clause 3.14, "spare part goods" means any individual parts issued as spares for the purposes of any equipment that we sell.

## 4. PRICE AND PRICE VARIATION

- 4.1 The maximum prices of the goods will be quoted on the Site and in the price lists accompanying our advertising brochures at the time you submit Your Order.
- 4.2 Blue Seal is entitled to adjust any price to take into account a variation in cost arising from:
- 4.2.1 delays in manufacture or installation as a result of any act or omission by the buyer, or other circumstances beyond Blue Seal's control;
- 4.2.2 variations in Blue Seal's costs of manufacture including, without limitation, variations in the cost of labour or raw materials;
- 4.2.1 variations in the cost of the goods to Blue Seal due to variations in the cost of freight and transport, insurance premiums, customs duties or currency exchange rates; and
- 4.2.2 any error or omission.
- 4.3 In addition, the maximum prices of the goods may be adjusted to reflect discounts we are willing to provide you with. The price payable for the goods under the contract will be confirmed in the Order Confirmation. The Order Confirmation will also confirm the relevant delivery costs payable.
- 4.4 The price of goods set out on the Site and in the price lists accompanying our advertising brochures exclude VAT (where applicable). VAT will be charged on goods at the applicable current rate chargeable in the UK from time to time. If the rate of VAT changes between the date you enter into a contract for goods and the date of delivery, we will adjust the VAT you pay, unless you have already paid for the good in full before the change in VAT takes effect.
- 4.5 The Site and our advertising brochures contain a large number of goods. It is always possible that, despite Blue Seal's reasonable efforts, some of the goods on the Site and/or in our advertising brochures may be incorrectly priced. If Blue Seal discovers an error in the price of the goods you have ordered Blue Seal will contact you to inform you of this error and Blue Seal will give you the option of continuing to purchase the goods at the correct price or cancelling Your Order. Blue Seal will not process Your Order until Blue Seal have your instructions. If Blue Seal are unable to contact you using the contact details you have provided as part of the ordering process, Blue Seal will treat the contract as cancelled and notify

you in writing. If Blue Seal mistakenly accepts and processes Your Order where a pricing error is obvious and unmistakeable and could reasonably have been recognised by you as a mispricing, Blue Seal may cancel Your Order and refund you any sums you have paid.

## 5. TERMS OF PAYMENT

5.1 Payment is to be made in full on goods sold by Blue Seal prior to delivery (such date to be confirmed in the Order Confirmation), save where the buyer has been granted a credit account. In these circumstances, subject to the terms on which we have agreed to provide you with a credit account permitting the goods to be charged to your account (to be agreed under separate terms), payment must be made by you to us within 30 days from the date Blue Seal's invoice or within such other timeframe as agreed with you.

5.2 Where the buyer has a credit account with Blue Seal, Blue Seal reserves the right to impose on the buyer a minimum deposit to Blue Seal of 25% of the purchase price for goods.

5.3 In the event of default by the buyer under clause 5.1 or 5.2, all debt recovery costs, including legal costs on a solicitor /own client basis and disbursements, and any mercantile agent costs charged to Blue Seal will be part of the indebtedness of the buyer to Blue Seal and will be paid to Blue Seal on request.

5.4 Without prejudice to any other remedy, if you fail to make any payment due to Blue Seal under the Contract Terms by the due date for payment, Blue Seal may charge you interest on the overdue amount at the rate set out in the Late Payment of Commercial Debts (Interest) Act 1998 from time to time. Such interest shall accrue on a daily basis from the due date until actual payment of the overdue amount, whether before or after judgment. The buyer shall pay the interest together with the overdue amount.

5.5 Blue Seal accepts payment by the payment methods stated on the Site and in our advertising brochures.

5.6 You authorise Blue Seal to debit the amount that is payable in respect of an accepted order from you in accordance with your nominated payment method.

5.7 You must not pay, or attempt to pay, for a good using any fraudulent or unlawful means.

5.8 Your nominated payment method may trigger fraud prevention protocols. If this occurs, Blue Seal may contact you to confirm additional details, or cancel the transaction.

5.9 To the extent permitted by law, Blue Seal (and its assignees) exclude all liability for any loss or damage suffered or incurred by you (whether directly or indirectly) where a credit card is used fraudulently or in an unauthorised manner.

## 6. VARIATION OF TERMS OF PAYMENT

6.1 If Blue Seal decides that the credit worthiness of the buyer has become unsatisfactory, Blue Seal may on written notice to the buyer:

- 6.1.1 vary the terms of payment, and may require payment in full and in cash, and/or the provision of security, for any amount unpaid and the buyer will pay in the timeframe stipulated by Blue Seal; and
- 6.1.2 stop any goods in transit until any requirements under this clause have been complied with.

## 7. COMPLETION AND DELIVERY

7.1 Blue Seal will endeavour to deliver goods within a reasonable time (in the absence of an agreement with you).

7.2 Delivery of an order shall be completed when Blue Seal deliver the goods to the address agreed between the parties (even if this is Blue Seal's address) or a carrier organised by the buyer collect them from Blue Seal.

7.3 Blue Seal may suspend delivery, supply or completion and/or terminate the contract where the failure to deliver, supply or complete is caused by force majeure, including any outbreak of disease where such outbreak is designated a serious threat to public health, any control, direction, law or measure imposed issued or administered by any governmental, statutory or regulatory body or person imposed or administered as a response to an outbreak of disease or as a means of preventing the significant transmission of a disease, in each case anywhere in the United Kingdom and any act or omission on the part of the buyer, or by any act of God, war lightning, fire, earthquake, storm, flood, explosion, any embargoes, restraint orders or restrictions imposed directly or indirectly by any government or governmental authority, agency or department, unavailability or delay in availability of equipment materials or transport, labour dispute and any other case whether of the kind enumerated or otherwise which is not within the control of Blue Seal.

7.4 Unfortunately, Blue Seal does not deliver to addresses outside the UK and Ireland.

## 8. WITHHOLDING SUPPLY AND DELIVERY BY INSTALMENTS

8.1 Blue Seal reserves the right to withhold supply to the buyer if the buyer is in breach of any contract with Blue Seal.

8.2 Blue Seal reserves the right to deliver the goods by instalments and each instalment shall be deemed to be sold under a separate contract incorporating these Contract Terms. Failure of Blue Seal to deliver any instalment shall not entitle the buyer to cancel the balance of the contract. Exercise of these rights does not entitle the buyer to terminate any contract with Blue Seal or claim any loss or damage.

## 9. TITLE AND RISK

9.1 The risk in the goods passes to you when the goods are fully loaded for transportation to you at Blue Seal's warehouse.

9.2 All payments received from the buyer may be applied by Blue Seal in the manner Blue Seal, in its absolute discretion, determines.

9.3 Subject to clauses 9.4 and 9.5, legal and beneficial ownership of the goods will not pass to the buyer until Blue Seal has received in full in cleared funds:

- 9.3.1 all sums due to it in respect of the goods; and
- 9.3.2 all other sums which are or which become due to Blue Seal from the buyer on any account whatsoever.

9.4 The buyer may resell the goods in the ordinary course of its business and, if it does so, legal and beneficial ownership of goods will pass to the buyer immediately prior to the buyer entering into a binding contract for the sale of those goods.

9.5 Blue Seal may, by giving written notice to the buyer, pass legal and beneficial ownership of the goods (or any of them) to the buyer at any time before such ownership would otherwise have passed to the buyer.

9.6 Until ownership of the goods has passed to the buyer, the buyer will:

- 9.6.1 hold the goods on a fiduciary basis as Blue Seal's bailee;
- 9.6.2 store the goods (at no cost to Blue Seal) separately from all other goods of the buyer or any third party in such a way that they remain readily identifiable as the Blue Seal's property;
- 9.6.3 not destroy, deface or obscure any identifying mark or packaging on or relating to the goods;
- 9.6.4 not, without Blue Seal's prior written consent, annex any goods to its premises or property;
- 9.6.5 maintain the goods in a satisfactory condition; and
- 9.6.6 keep the goods insured for their full price against damage or loss on an "all risks" basis with reputable insurers in the UK market and whenever requested by Blue Seal produce a copy of the policy of insurance in respect of the goods to Blue Seal, do nothing and not omit to do anything which in consequence permits any insurer to refuse to indemnify the buyer in full in accordance with the terms of any insurance policy maintained in respect of the goods in respect of any claim made under any such insurance policy and ensure that any insurance proceeds received by the buyer under the relevant policy are applied to repairing damaged goods or, in the event that they are not so applied, hold such proceeds on trust for Blue Seal.

9.7 The buyer may use the goods in the ordinary course of its business before ownership has passed to it.

9.8 If the buyer resells any goods, the buyer will hold such part of the proceeds of sale as represents the amount owed by the buyer to Blue Seal on trust for Blue Seal and will account to Blue Seal accordingly.

9.9 The buyer's right to possession, use and resale of the goods will terminate immediately if, before ownership of the goods passes to the buyer in accordance with clauses 9.3, 9.4 or 9.5:

- 9.9.1 the buyer becomes insolvent;
- 9.9.2 the buyer fails to pay any sum due to Blue Seal under any contract on or before the due date or is in breach of any of its obligations under these Contract Terms or any contract;
- 9.9.3 these Contract Terms expires or terminates for any reason.

9.10 Once the goods are delivered to the buyer, Blue Seal will be entitled to recover payment for the goods (including by way of an action for the price) notwithstanding that ownership of any of the goods has not passed from Blue Seal.

9.11 The buyer grants, and will procure that the owner of any relevant third party premises grants, Blue Seal, its agents, employees and sub-contractors an irrevocable licence at any time to enter any premises where the goods are or may be stored in order to inspect them, or, where the buyer's right to possession, use and resale has terminated, to recover them.

9.12 If the buyer's right to possession, use and resale of the goods terminates in accordance with clause 9.9, Blue Seal will be entitled to issue the buyer with a credit note for all or any part of the price of the goods together with VAT thereon.

9.13 Blue Seal's rights contained in this clause 9 will survive expiry or termination of a contract however arising.

9.14 The buyer warrants that it does not intend to use the goods predominantly for personal, domestic or household purposes.

## 10. WARRANTY

10.1 Blue Seal warrants to the buyer that on delivery, and for a period of 1 (one) year for equipment or 90 (ninety) days for spare parts from the date of invoice (Warranty Period) the goods shall conform with their written technical specification set out on the Site and in our advertising brochures.

10.2 If at any time during the Warranty Period, the buyer becomes aware of a breach of clause 10.1 above, the buyer shall:

- 10.2.1 advise Blue Seal in writing within 7 days after the buyer becomes aware of the breach prior to the expiry of the Warranty Period;
- 10.2.2 at Blue Seal's option, either return the goods to Blue Seal at the buyer's cost or permit Blue Seal to inspect it at the buyer's premises; and
- 10.2.3 provide Blue Seal with all information and assistance which Blue Seal may reasonably require to investigate the alleged breach.

10.3 Subject to clause 14.1, Blue Seal's only liability for breach of clause 10.1 above will be, at Blue Seal's option, to repair or replace the relevant good or to reduce the price of the relevant good by a sum which is equitable in the circumstances.

10.4 The buyer's only remedy for breach of the obligation at clause 10.3 will be in damages.

- 10.5 Subject to clause 14.1, Blue Seal will not have any liability for a breach of the warranty at clause 10.1 if:
- 10.5.1 you do not comply with your obligations at clause 10.2 in respect of the breach;
- 10.5.2 the relevant defect was caused by damage in transit after delivery;
- 10.5.3 the relevant defect was caused or exacerbated by improper use, handling, alteration, installation, repair, maintenance, storage or failure to comply with instructions provided by Blue Seal or the manufacturer; or
- 10.5.4 you make further use of the relevant good after discovering the relevant breach.
- 10.6 The warranty at clause 10.1 will apply to any goods which are repaired or replaced under clause 10.3 for the remainder of the original Warranty Period.
- 10.7 Separate to these Contract Terms, and without prejudice to any provisions set out in these Contract Terms, Blue Seal may provide end user consumer customers with a manufacturer's warranty.
- 11. INDEMNITY**
- 11.1 The buyer shall indemnify and keep Blue Seal indemnified against any action, claim, demand, loss, damage, cost or expense which:
- 11.1.1 Blue Seal may suffer or incur, or is liable for arising out of, or in connection with the storage, use, possession, or other act or omission of the buyer in respect of any goods supplied; or
- 11.1.2 may be brought by a third party arising out of or in connection with any goods supplied by Blue Seal to the buyer.
- 12. CLAIMS**
- 12.1 Without prejudice to clause 10, the buyer shall advise Blue Seal in writing of any claims:
- 12.1.1 for loss or damage – within 14 days of receipt of the goods; and
- 12.1.2 for non-delivery or a shortfall in delivery – within 7 days of agreed or reasonable delivery of the goods.
- 12.2 Blue Seal will advise the buyer of any rejected claim made pursuant to clause 12.1 in writing electronically, detailing the reason/s for rejection, after which payment in full will be required from the buyer for the value of the rejected claim.
- 13. DURABILITY**
- The durability of goods may be affected by neglect, misuse, spasmodic and/or irregular use and use of water that is outside the quality and/or temperature specifications of the goods.
- 14. LIABILITY**
- 14.1 Nothing in these Contract Terms limits or excludes our liability for:
- 14.1.1 death or personal injury caused by Blue Seal's negligence;
- 14.1.2 fraud or fraudulent misrepresentation (by Blue Seal or on its behalf);
- 14.1.3 breach of the terms implied by section 12 of the Sale of Goods Act 1979 (title and quiet possession); or
- 14.1.4 any liability which cannot be legally limited or excluded.
- Any liability of Blue Seal which falls within clause 14.1 will not be taken into account in assessing whether any of the financial limits in clause 14.3 has been reached.
- 14.2 Subject to clause 14.1, Blue Seal will under no circumstances whatever be liable to you, whether in contract, tort (including negligence), breach of statutory duty, or otherwise, arising under or in connection with the contract for:
- 14.2.1 any loss of profits, sales, business, or revenue;
- 14.2.2 loss or corruption of data, information or software;
- 14.2.3 loss of business opportunity;
- 14.2.4 loss of anticipated savings;
- 14.2.5 loss of goodwill; or
- 14.2.6 any indirect or consequential loss.
- 14.3 Subject to clause 14.1, Blue Seal's total liability to you in respect of all losses arising under or in connection with these Contract Terms or any contract, whether in contract, tort (including negligence), breach of statutory duty, or otherwise, shall in no circumstances exceed 200% of the price of the relevant goods in respect of which the liability relates.
- 14.4 Except as expressly stated in these Contract Terms, Blue Seal do not give any representation, warranties or undertakings in relation to the goods. Any representation, condition or warranty which might be implied or incorporated into these Contract Terms by statute, common law or otherwise is excluded to the fullest extent permitted by law. In particular, Blue Seal will not be responsible for ensuring that the goods are suitable for your purposes.
- 14.5 The exclusions from and limitations of liability set out in this clause 14 will be considered severally. The invalidity or unenforceability of any one sub-clause or clause will not affect the validity or enforceability of any other sub-clause or clause and they will be considered severable from each other.
- 15. RETURN OF DRAWINGS**
- 15.1 All drawings and specifications obtained by the buyer from Blue Seal or its employees or agents remain Blue Seal's property.
- 15.2 The buyer shall not, without the prior written consent of Blue Seal, utilise or reproduce such drawings or specifications or communicate them to a third party, except for the purpose for which they are supplied.
- 15.3 Except for Blue Seal's standard descriptive specifications, operating instructions, layout and foundation drawings, all drawings and specifications are to be returned to Blue Seal on completion of the contract or on request.
- 16. TERMINATION**
- 16.1 If the buyer:
- 16.1.1 commits a breach of the contract which cannot be remedied; or
- 16.1.2 commits a breach of a contract which can be remedied but fails to remedy that breach within 14 days of a written notice requiring it to be remedied being given by the Blue Seal,
- 16.2 Blue Seal may terminate the contract immediately by giving written notice to that effect to the buyer if the buyer becomes insolvent or makes any composition or arrangement with its creditors or steps are taken for the winding up of the buyer, or the buyer has a receiver appointed over any of its property or the buyer is unable to pay its debts as they fall due.
- 16.3 If the manufacture, dispatch or transport of goods is delayed due to any act or omission of the buyer, and that delay continues beyond a reasonable time, Blue Seal may treat the contract as terminated and a proportion of the price that reflects the work already done by Blue Seal together with any expenses and any additional costs attributable to such delay, shall become due and payable.
- 16.4 Following expiry or termination of the contract:
- 16.4.1 clauses 5, 9, 10, 11, 14, 15, 16, 17, 18 and 19 will continue in force, together with any other clauses which expressly or impliedly continue to have effect after expiry or termination of the contract; and
- 16.4.2 all other rights and obligations will immediately cease without prejudice to any rights, obligations, claims (including claims for damages for breach) and liabilities which have accrued prior to the date of expiry or termination.
- 17. GENERAL**
- 17.1 The contract constitutes the entire agreement between the parties and supersedes any prior agreement or arrangement in respect of its subject matter and:
- 17.1.1 neither party has entered into the contract in reliance upon, and it will have no remedy in respect of, any misrepresentation, representation or statement (whether made by the other party or any other person and whether made to the first party or any other person) which is not expressly set out in the contract;
- 17.1.2 the only remedies available for any misrepresentation or breach of any representation or statement which was made prior to entry into the contract and which is expressly set out in the contract will be for breach of contract; and
- 17.1.3 nothing in this clause 17.1 will be interpreted or construed as limiting or excluding the liability of any person for fraud or fraudulent misrepresentation.
- 17.2 A delay in exercising or failure to exercise a right or remedy under or in connection with the contract will not constitute a waiver of, or prevent or restrict future exercise of, that or any other right or remedy, nor will the single or partial exercise of a right or remedy prevent or restrict the further exercise of that or any other right or remedy. A waiver of any right, remedy, breach or default will only be valid if it is in writing in the circumstances and for the purpose for which it was given and will not constitute a waiver of any other right, remedy, breach or default.
- 17.3 If any term of the contract is found by any court or body or authority of competent jurisdiction to be illegal, unlawful, void or unenforceable, such term will be deemed to be severed from the contract and this will not affect the remainder of the contract which will continue in full force and effect.
- 17.4 No variation to the contract will be effective unless it is in writing and signed by a duly authorised representative on behalf of each of the parties.
- 17.5 Nothing in the contract and no action taken by the parties in connection with it or them will create a partnership or joint venture or relationship of employer and employee between the parties or give either party authority to act as the agent of or in the name of or on behalf of the other party or to bind the other party or to hold itself out as being entitled to do so.
- 17.6 Each party agrees that it is an independent contractor and is entering into the contract as principal and not as agent for or for the benefit of any other person.
- 18. GOVERNING LAW AND JURISDICTION**
- 18.1 These Contract Terms any dispute or claim arising out of or in connection with their subject matter or formation (including non-contractual disputes or claims) shall be governed by and construed in accordance with the law of England and Wales.
- 18.2 Blue Seal and the buyer both irrevocably agree that the courts of England and Wales shall have exclusive jurisdiction to settle any dispute or claim arising out of or in connection with these Contract Terms or their subject matter or formation (including non-contractual disputes or claims).
- 19. INTERPRETATION**
- 19.1 In these Contract Terms the following words will (unless the context otherwise requires) have the following meanings:
- 19.1.1 "buyer"/ "you"/ "your" means and includes the buyer and any servant, agent, partner, contractor or employee of that party;
- 19.1.2 "Blue Seal" includes all Blue Seal's employees and agents;
- 19.1.3 "we"/ "our"/ "us" means Blue Seal;
- 19.1.4 a reference to the "parties" means Blue Seal and the buyer; and
- 19.1.5 a reference to "including" means "including without limitation".

# **BLUE SEAL®**



POWER • PERFORMANCE • RELIABILITY



## PRODUCT PRICE LIST APRIL 2026

Blue Seal Limited,  
Unit 67, Gravelly Business Park, Gravelly, Birmingham B24 8TQ

T: 0121-327-5575 | F: 0121-327-9711 | [sales@blue-seal.co.uk](mailto:sales@blue-seal.co.uk) | [www.blue-seal.co.uk](http://www.blue-seal.co.uk)

In line with our policy to continually develop and improve our products, Blue Seal Limited reserves the right to change specifications without notice

